

# LONDON D2

Ⓓ Montageanleitung

Ⓐ Handleiding voor de montage

Ⓙ Montaj talimatı

Ⓕ Notice de montage

Ⓒ Montážní návod

Ⓗ Szerelési útmutató

Ⓒ Assembly Instructions

Ⓐ Instrukcja montażu

Ⓙ Инструкция по монтажу

Ⓕ Istruzioni di montaggio

Ⓒ Návod na montáž

Ⓗ Instrucțiunile de montaj

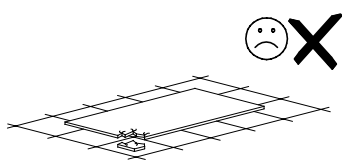
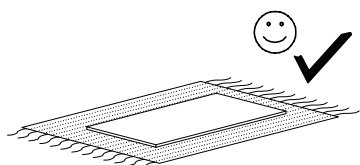
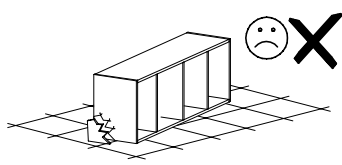
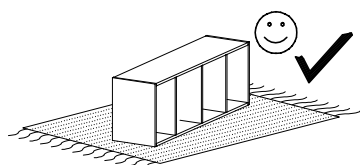
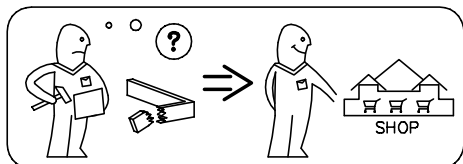
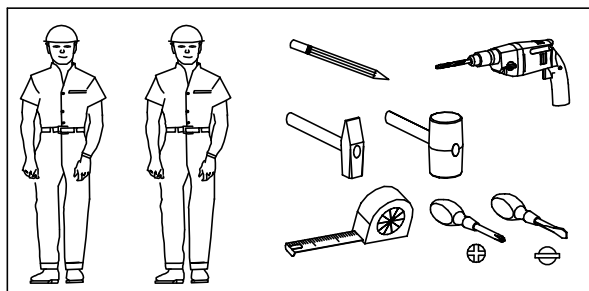
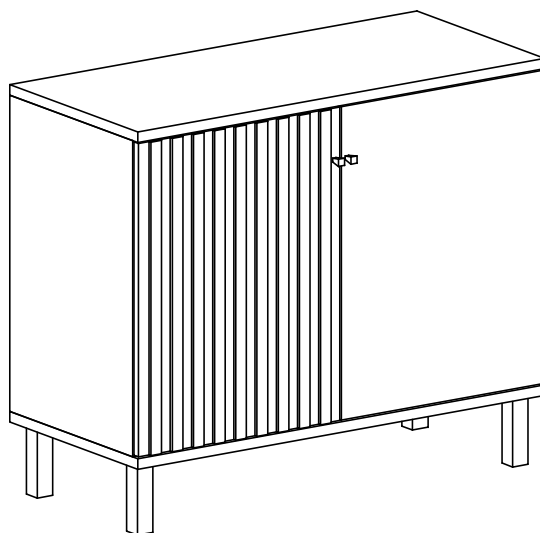

**Uwaga – Upozornini – Achtung – Attention – Caution – Figyelem  
Attenzione – Opgelet – Внимание – Atentie – Upozornenie – Dikkat**

PL	Czyszczenie należy wykonać wyłącznie za pomocą ściereczki lub lekko nawilżonego ręcznika. Nie stosować środków czyszczących do szorowania.
CZ	Čistění je nutné vykonávat výhradně pomoci utěrky nebo lehce navlhčeného ručniku. Nepoužívejte čisticí prostředky obsahující abrazivní částice.
D	Bitte nur mit einem Staubtuch oder leicht feuchtem Lappen reinigen. Keine scheuernden Putzmittel verwenden.
GB	Please only clean with duster or damp cloth. Do not use any abrasive cleaners.
F	Le nettoyage se fait uniquement à l'aide d'un torchon ou d'une serviette légèrement mouillée.
HU	A tisztítás kizárólag törleruha vagy enyhén nedvesített törölköző segítségével végezhető. Súroló hatású tisztítószerket nem szabad használni.
I	Pulire esclusivamente con un panno o un asciugamano umido.
NL	Reinig allen met een stofdoek of een lichtjes vochtige doek. Gebruik geen schurende poetsmiddelen.
RU	Очищайте от пыли тряпкой или слегка влажной ветошью. Не допускаются применение чистящих средств, не пред-назначенных для ухода за мебелью.
RO	Curabare trebuie efectuată numai cu o cârpă sau cu un prosop usor umzeit. Nu utilizati agenți de curabare abrazivi.
SK	Čistení je nutné vykonávat výhradne pomoci utierky nebo ľahko zvlhnutým ručnikom. Nepoužívajte čistiace prostriedky obsahujúci abrazívni častice.
TR	Lütfen sadece bir toz bezile veya hafif nemli yumusak bir bezle siliniz. Asindirici temizlik malzemeleri kullanmayiniz.

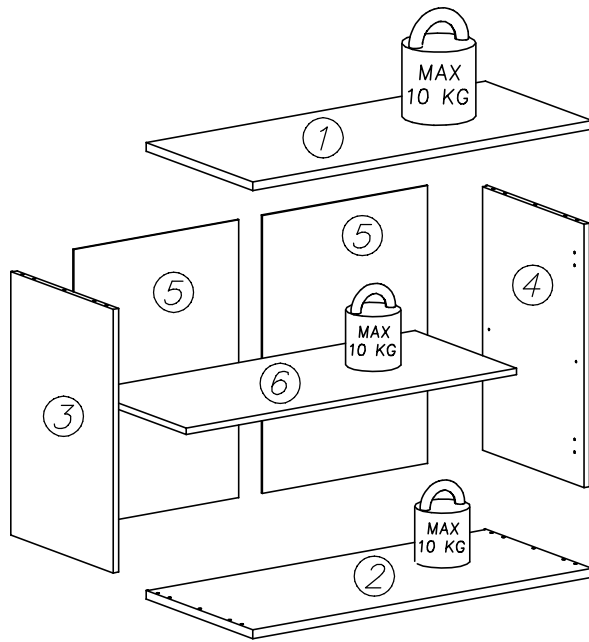
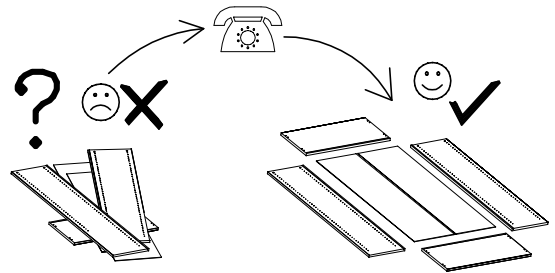
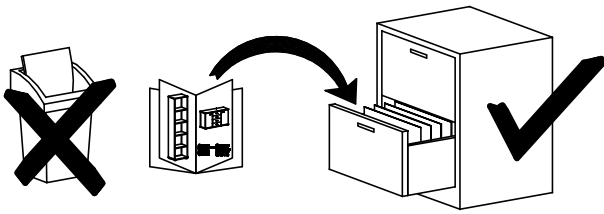

WYMIARY ELEMENTÓW  
 PART GUIDE  
 MASSE DER BAUTEILE

No.	L[mm]	W[mm]	T[mm]	Stc.
1	450	1002	22	1
2	450	1002	22	1
3	660	432	16	1
4	660	432	16	1
5	492	688	2,5	2
6	428	967	16	1
7	654	496	16	1
8	654	496	16	1

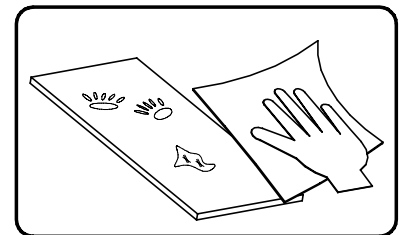
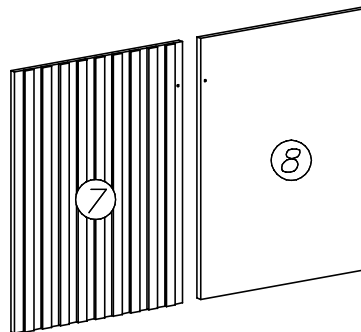

<b>P4</b>  x...(4)	<b>K1</b>  ø15x12 x...(8)	<b>K5</b>  x...(8)			
<b>N31</b>  M6x35 x...(4)	<b>I12</b>  x...(8)	<b>D3</b>  x...(4)	<b>C3</b>  x...(4)	<b>G8</b>  4x30 x...(2)	<b>E26</b>  x...(2)
<b>S1</b>  x...(1)	<b>B1</b>  ø8x35 x...(12)	<b>F1</b>  x...(4)	<b>W2</b>  x...(1)	<b>G4</b>  4x16 x...(8)	<b>W4</b>  x...(35)

I

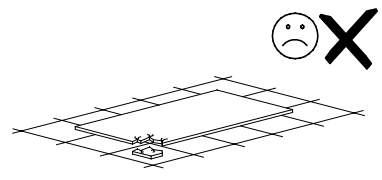
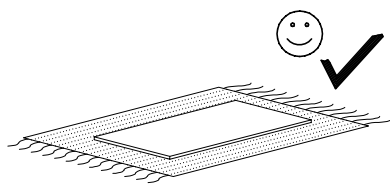

K1		ø15x12	x...(8)	K5		x...(8)	
				D3		x...(4)	
				B1		ø8x35	x...(12)
				F1		x...(4)	

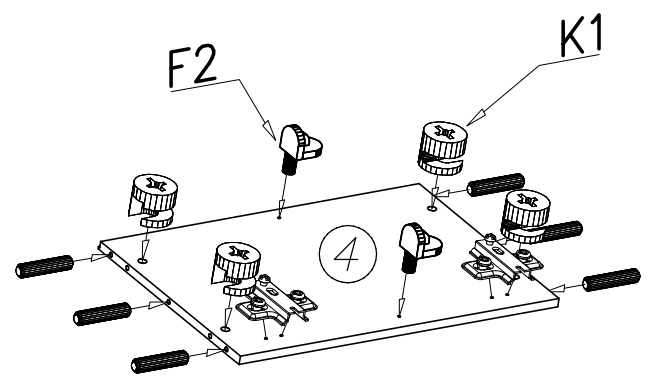
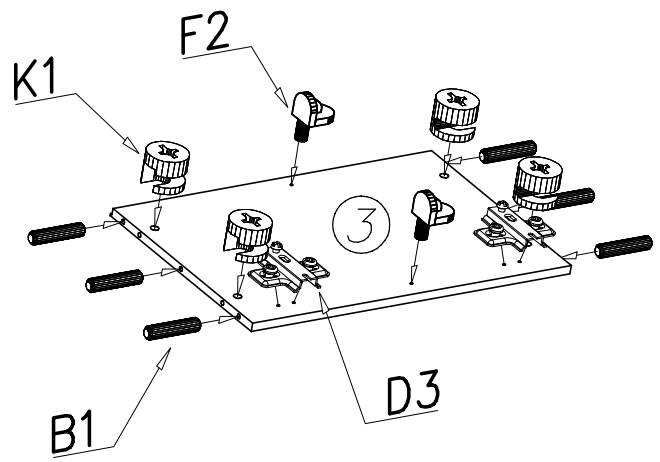
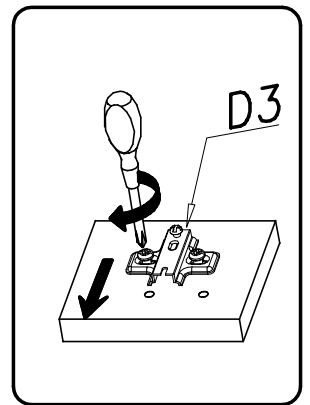
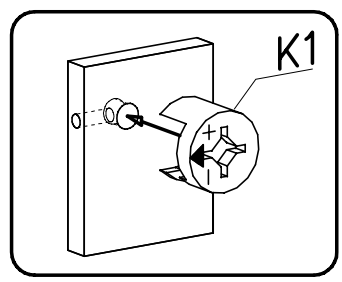
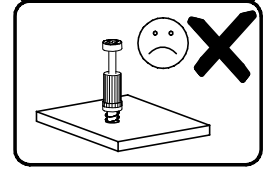
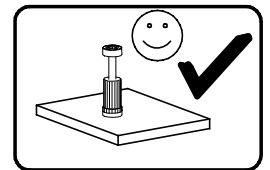
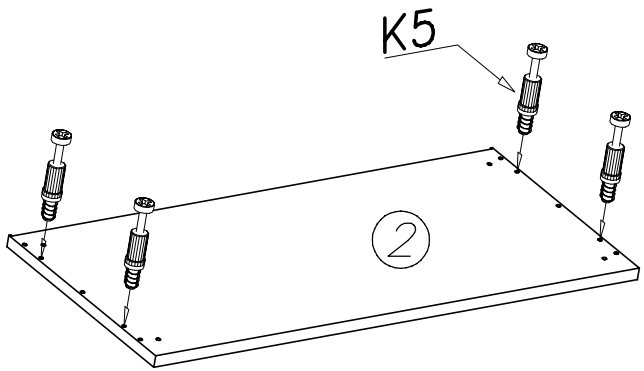
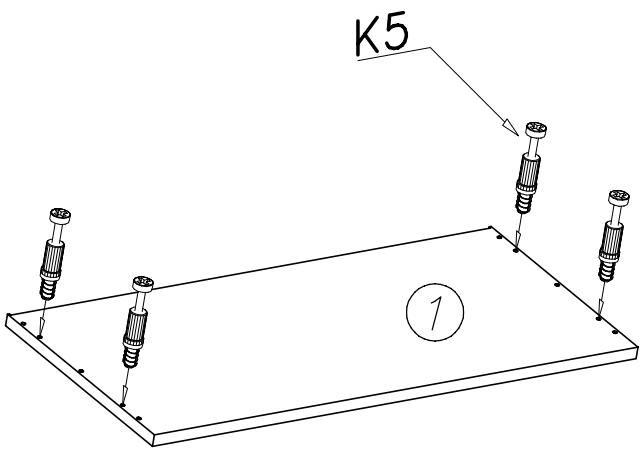

II

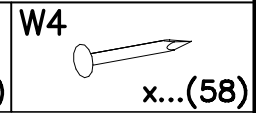
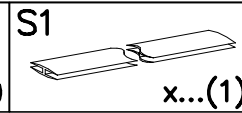
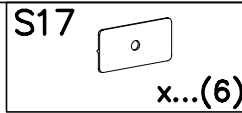
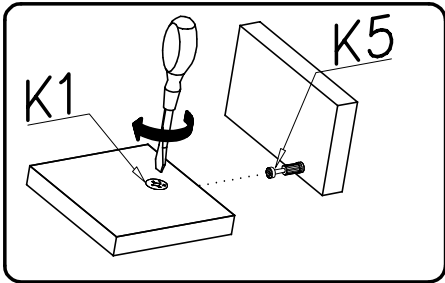
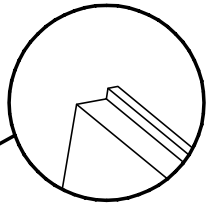
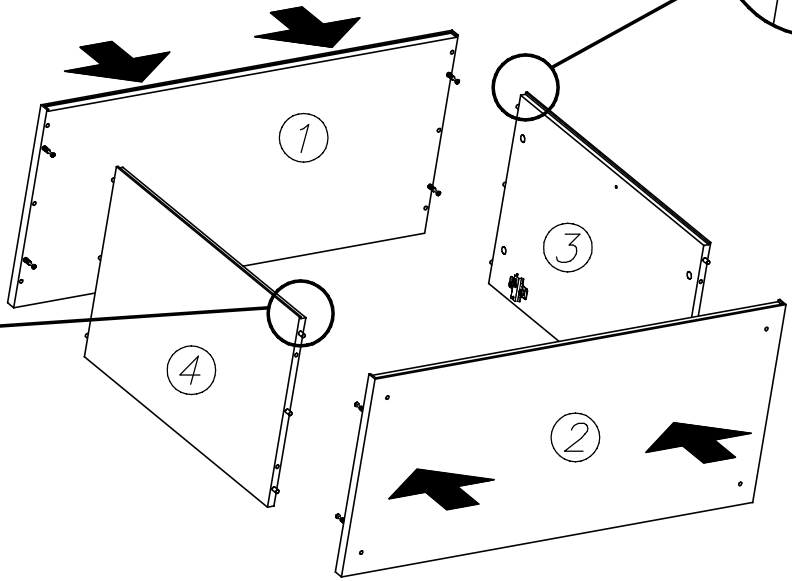
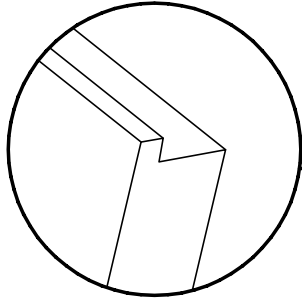
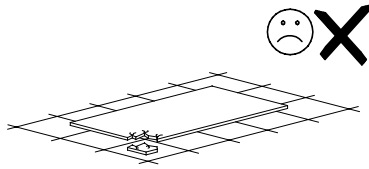
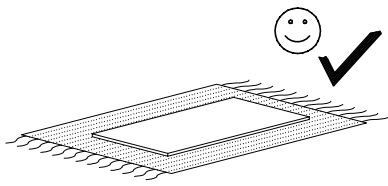

III

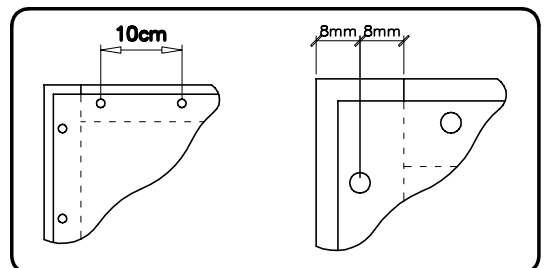
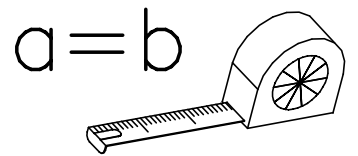
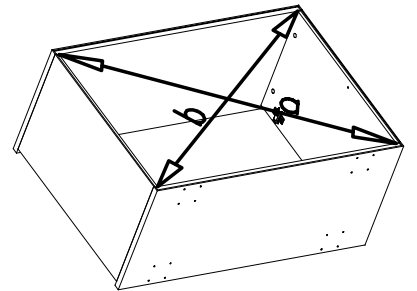
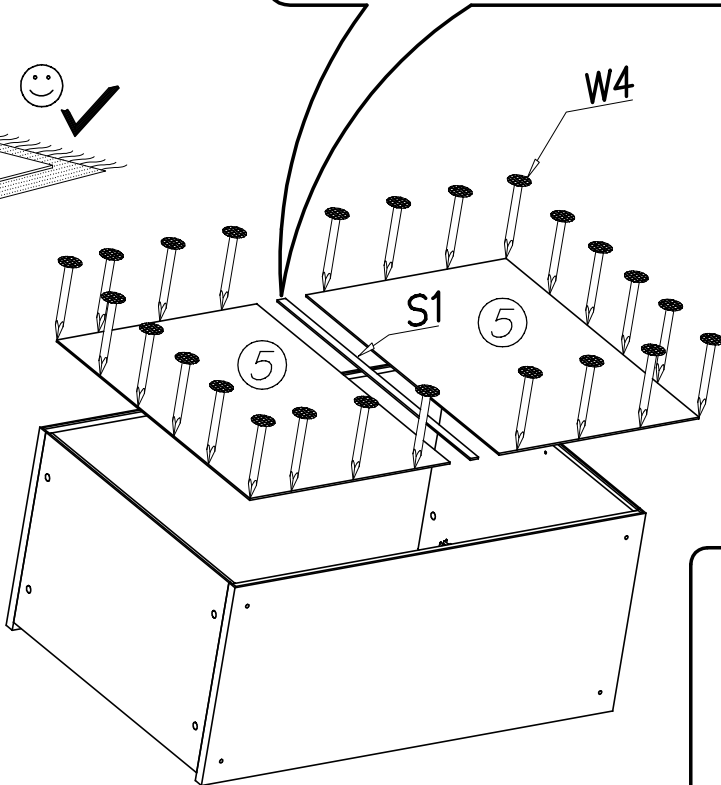
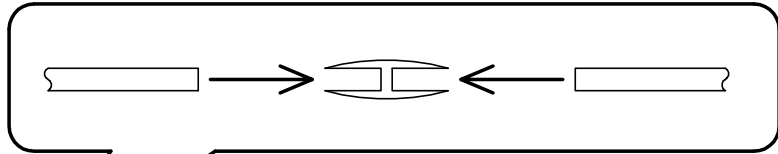
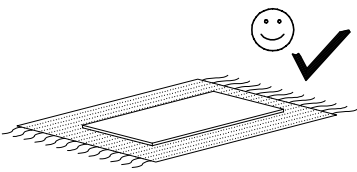
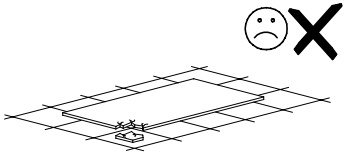

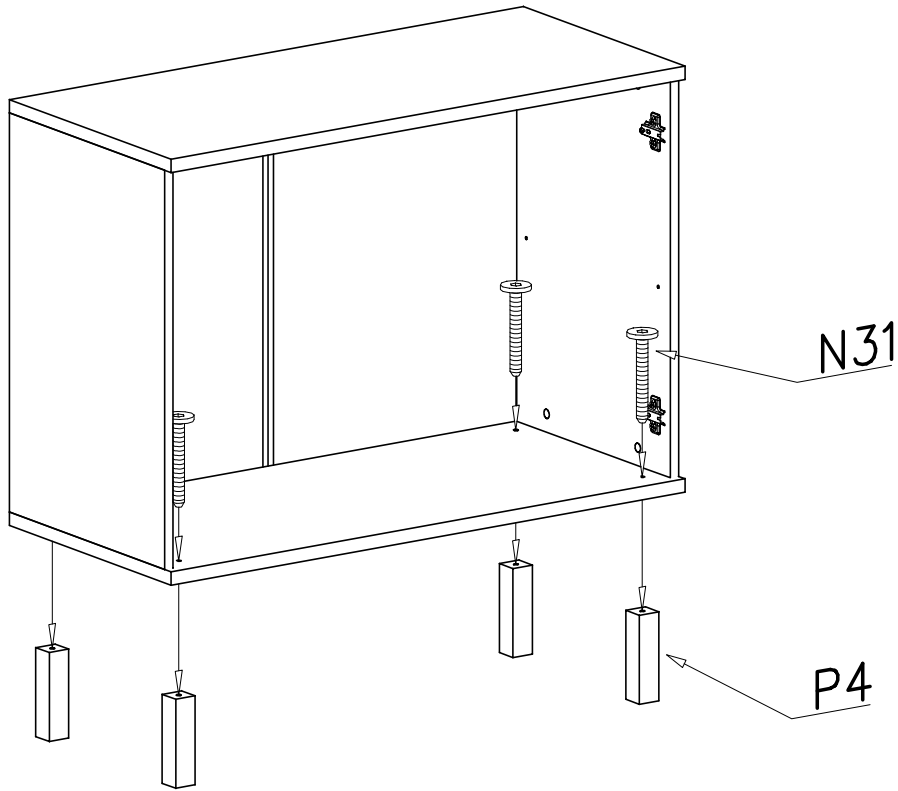

# IV

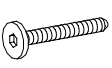

P4		x...(4)
N31		x...(4)
M6x35		x...(4)

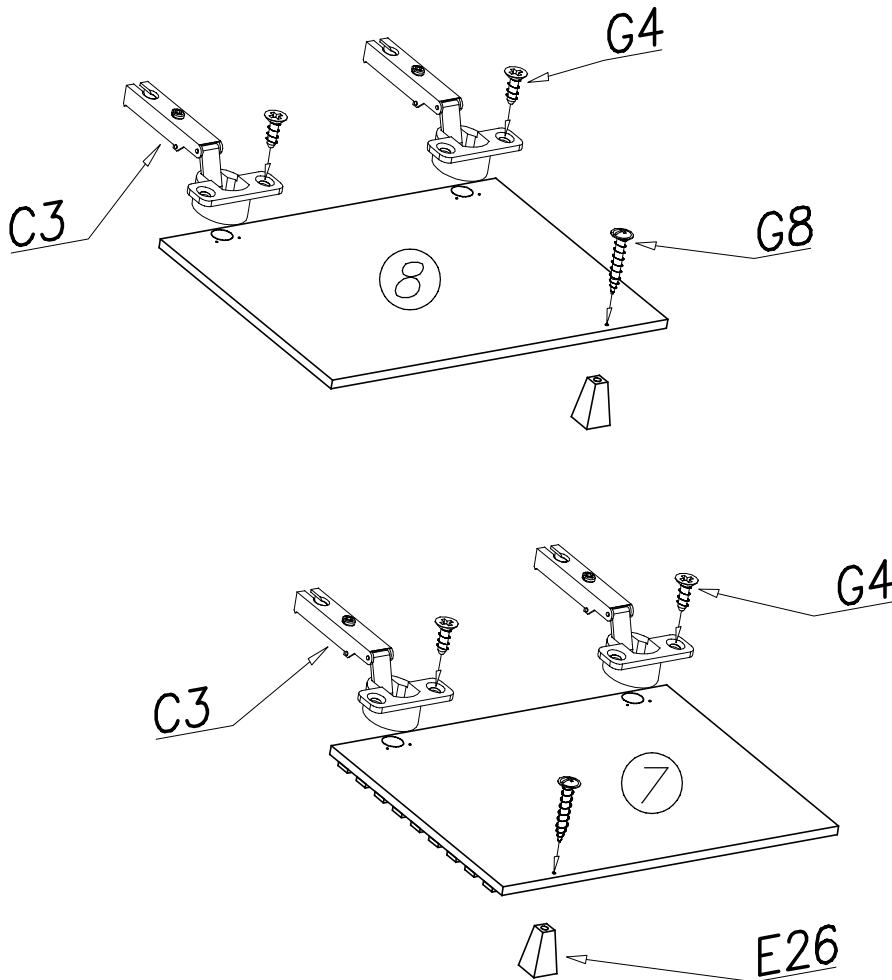
# V

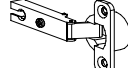

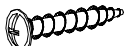
C3		x...(4)	E26		x...(2)
G4		x...(8)	G8		x...(2)
4x16			4x30		

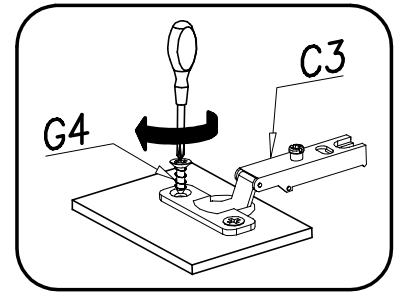

VI

