

- PL Instrukcja montażu  
 DE Montageanleitung  
 NL Handleiding voor de montage  
 TR Montaj talimatı  
 FR Notice de montage  
 CZ Montážní návod  
 HU Szerelési útmutató  
 GB Assembly instructions  
 RU Инструкция по монтажу  
 IT Istruzioni di montaggio  
 SK Návod na montáž  
 RO Instrucțiuni de montaj  
 ES Instrucciones de montaje  
 PT Instruções de montagem

Producent - Produzent - Üretici - Producteur - Výrobce -  
 Termelő - Producer - Produttore - Producător - Productor  
**MEBLE LASKI KACZOROWSKA SP.K.**  
 Laski, ul. Kępińska 21, 63-620 Trzczinica  
 meble-laski@meble-laski.com.pl

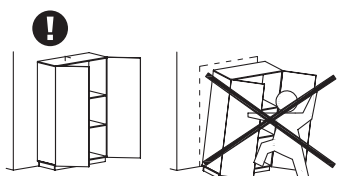

2025-01-03

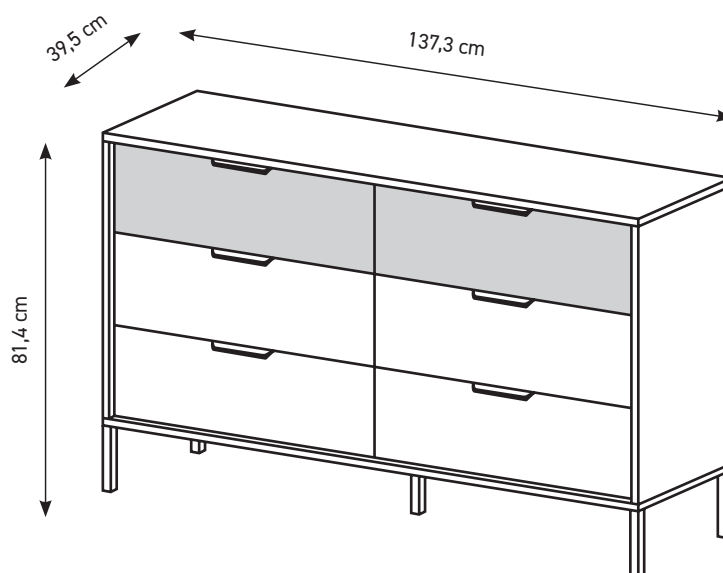
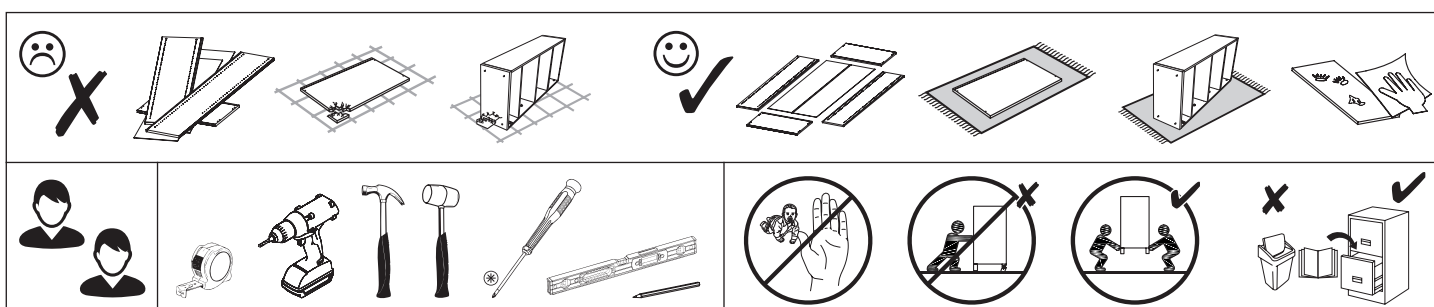



**PL** Przed rozpoczęciem montażu mebla wszystkie elementy należy sprawdzić czy nie są uszkodzone. W przypadku wykrycia uszkodzenia elementu należy odstąpić od montażu mebla i złożyć reklamację. Nie wolno przekraczać podanych maksymalnych wartości obciążenia. W innym przypadku można mebel uszkodzić lub zniszczyć.

Przed zawieszeniem mebla, lub przymocowaniem go do ściany (w celu zabezpieczenia przed przewróceniem), sprawdź wcześniej rodzaj i wytrzymałość ściany. Dobierz odpowiednie kołki i wkręty do rodzaju ściany. W przypadku wątpliwości skontaktuj się ze specjalistą. Montaż musi zostać wykonany przez osobę kompetentną. Meble zawierające płyty drewnopochodne mogą emitować substancje zanieczyszczające do powietrza w pomieszczeniu. Dlatego zaleca się, po zamontowaniu mebli, częste wietrzenie pomieszczenia przez co najmniej cztery tygodnie.

**DE** Vor Beginn der Möbelmontage sollten alle Elemente auf Beschädigungen überprüft werden. Wenn ein Element des Produkts beschädigt ist, installieren Sie das Produkt bitte nicht und reichen Sie eine Beschwerde ein. Überschreiten Sie die angegebenen Maximalbelastungen nicht. Andernfalls kann das Möbelstück beschädigt oder zerstört werden.

Bevor Sie ein Möbelstück an einer Wand aufhängen oder befestigen (um es gegen Umkippen zu sichern), prüfen Sie Art und Tragfähigkeit der Wand. Wählen Sie die für die Wand geeigneten Dübel und Schrauben. Im Zweifelsfall kontaktieren Sie bitte einen Fachmann. Die Montage muss durch eine sachkundige Person ausgeführt werden. Möbel mit Holzwerkstoffplatten können Schadstoffe in die Raumluft abgeben, daher Es wird empfohlen, den Raum nach dem Einbau der Möbel mindestens vier Wochen lang häufig zu lüften.

**FR** Avant de commencer l'assemblage du meuble, tous les éléments doivent être vérifiés pour déceler tout dommage. Si un élément du produit est endommagé, veuillez ne pas installer le produit et déposer une plainte. Ne dépassez pas les charges maximum indiquées. Sinon, le meuble peut être endommagé ou détruit.

Avant de suspendre le meuble ou de le fixer au mur (dans le but d'éviter un renversement), vérifiez au préalable le type et la résistance du mur. Utilisez les chevilles et les vis adaptées au type de mur. En cas de doute, veuillez contacter un spécialiste. Le montage doit être réalisé par une personne compétente. Les meubles contenant des panneaux à base de bois peuvent émettre des substances polluantes dans l'air intérieur. Donc il est recommandé, après l'installation des meubles, d'aérer fréquemment la pièce pendant au moins quatre semaines.

**CZ** Před zahájením montáže nábytku je třeba zkontrolovat poškození všech prvků. Pokud je některý prvek produktu poškozen, zdržte se instalace produktu a podejte stížnost. Nepřekračujte uvedené maximální zatížení. V opačném případě může dojít k poškození nebo zničení nábytku. Před zavěšením nábytku nebo jeho připevněním ke zdi (za účelem zajištění před převrácením) dřive zkontrolujte druh a odolnost stěny. Vyberte k druhu stěny vhodné hmoždinky a šrouby. V případě pochybností kontaktujte specialistu. Montáž musí být provedena kompetentní osobou. Nábytek obsahující panely na bázi dřeva může uvolňovat znečišťující látky do vnitřního ovzduší. Proto doporučuje se po instalaci nábytku místnost pravidelně větrat po dobu nejméně čtyř týdnů.

**HU** A bűtorszerelés megkezdése előtt ellenőrizni kell az összes elem sérülését. Ha a termék bármely eleme megsérült, kérjük, tartózkodjon a termék telepítésétől és nyújtson be panaszt. A megadott maximális terhelési értékeket nem szabad túllépni. Ellenkező esetben a bűtor megsérülhet vagy megsemmisülhet.

A bűtor felfüggesztése illetve falhoz való rögzítése (megakadályozván ezzel eldőlésének lehetőségét) előtt ellenőrizze a fal fajátékát és szilárdságát. Megfelelő, a falhoz illő tipliket és csavarokat használjon. Ha kétsége támadna, konzultáljon szakemberrel. A felszerelés csak egy hozzáértő szakember végezheti el. A fa alapú panelek tartalmazó bűtorok szennyező anyagokat bocsáthatnak ki a beltéri levegőbe. Ezért Ajánlott a bűtorok beszerelése után legalább négy hétig rendszeresen szellőztetni a helyiséget.

**GB** Before starting the furniture assembly, all elements should be checked for damage. If any element of the product is damaged, please refrain from installing the product and file a complaint. The specified maximum load values must not be exceeded. Otherwise, the piece of furniture may be damaged or destroyed.

Before suspending or fixing furniture to the wall (in order to prevent falling over), check the type and strength of the wall. Select wall plugs and screws appropriate for the given type of the wall. In the case of doubts, contact a specialist. The installation must be performed by a competent person. Furniture containing wood-based panels can emit polluting substances into the indoor air. Therefore recommended, after installing the furniture, to ventilate the room frequently for at least four weeks.

**SK** Pred začatím montáže nábytku by sa mali skontrolovať všetky prvky, či nie sú poškodené. Ak je ktorýkoľvek prvok výrobku poškodený, neinstalujte výrobok a reklamujte ho. Uvedené hodnoty maximálneho zaťaženia nesmú byť prekročené. V opačnom prípade môže dôjsť k poškodeniu alebo zničeniu nábytku.

Pred zavesením nábytku alebo jeho pripavením na stenu (za účelom zaistenia pred prevrátením) predtým skontrolujte druh a odolnosť steny. Vyberte k druhu steny vhodné hmoždinky a skrutky. V prípade pochybností kontaktujte špecialistu. Montáž musí byť vykonaná kompetentnou osobou. Nábytok obsahujúci dosky na báze dreva môže vylučovať znečisťujúce látky do vnútorného ovzdušia. Preto odporúča sa po inštalácii nábytku miestnosť pravidelne vetrať aspoň štyri týždne.

**IT** Prima di iniziare l'assemblaggio del mobile, tutti gli elementi dovrebbero essere controllati per danni. Se qualche elemento del prodotto è danneggiato, astenersi dall'installare il prodotto e presentare un reclamo. I valori di carico massimo specificati non devono essere superati. In caso contrario, il mobile potrebbe essere danneggiato o distrutto.

Prima di appendere i mobili, oppure attaccarli al muro (per proteggerli da ribaltamenti), verifica prima la tipologia e resistenza del muro. Scegli i tasselli e viti più adatti per il tipo di muro. In caso di dubbi contattare uno specialista. Il montaggio deve essere fatto da una persona competente. I mobili contenenti pannelli a base di legno possono emettere sostanze inquinanti nell'aria interna. Perciò si consiglia, dopo aver installato i mobili, di aereare frequentemente il locale per almeno quattro settimane.

**NL** Voordat u met de meubelmontage begint, moeten alle elementen op schade worden gecontroleerd. Als een onderdeel van het product beschadigd is, installeer het dan niet en dien een klacht in. Overschrijd de aangegeven maximale belastingen niet. Anders kan het meubelstuk worden beschadigd of vernield.

Voordat u het meubel ophangt of bevestigt tegen de muur (om het te beschermen tegen omvallen) dient u het type en de duurzaamheid van deze muur na te kijken. Maak gebruik van pluggen en schroeven die geschikt zijn voor het type muur. Neem in geval van twijfels contact op met een specialist. De assemblage dient te worden uitgevoerd door iemand met kennis van zaken. Meubels met panelen op houtbasis kunnen vervuilende stoffen in de binnenlucht uitstoten. Daarom Het is raadzaam om na het plaatsen van het meubilair de ruimte minimaal vier weken regelmatig te ventileren.

**TR** Mobilya montajına başlamadan önce tüm elemanlarda hasar olup olmadığını kontrol edilmelidir. Ürünün herhangi bir parçası hasar görmüşse, lütfen ürünü kurmayın ve şikayette bulunun.

Belirtilen azami yük değerini aşmayınız, aksi takdirde mobilya parçaları zarar görebilir veya kullanılamaz hale gelebilir. Mobilyayı duvara asmadan veya montaj etmeden önce (devrilmesini önlemek için) duvarın türünü ve dayanıklılığını kontrol edin. Duvara uygun dübelleri ve vidaları seçin. Emin olamamanız durumunda bir uzman ile iletişime geçin. Kurulum yetkilili bir kişi tarafından yapılmalıdır. Ahşap bazı paneller içeren mobilyalar iç mekan havasına kirletici maddeler yayabilir. Öyleyse Mobilyaların kurulumundan sonra odanın en az dört hafta boyunca sık sık havalandırılması önerilir.

**RO** Înainte de a începe asamblarea mobilierului, toate elementele trebuie verificate pentru a nu se deteriorează. Dacă vreun element al produsului este deteriorat, vă rugăm să vă abțineți de la instalarea produsului și să depuneți o reclamație.

Valoriile maxime de sarcină specificate nu trebuie depășite. În caz contrar, piesa de mobilier poate fi deteriorată sau distrusă. Înainte de suspendarea unei piese de mobilier sau atașarea acestuia la perete (pentru a preveni bascularea), verificați în prealabil tipul și gradul de rezistență a peretelui. Montați diblurile și șuruburile adecvate pentru tipul de perete. În caz de îndoieli, consultați un specialist. Instalarea trebuie să fie efectuată de către o persoană competentă. Mobilierul care conține panouri pe bază de lemn poate emite substanțe poluante în aerul interior. Prin urmare se recomandă ca, după montarea mobilierului, aerisirea frecvența a încăperii timp de cel puțin patru săptămâni.

**ES** Antes de comenzar el montaje de los muebles, todos los elementos deben comprobarse en busca de daños. Si algún elemento del producto está dañado, absténgase de instalar el producto y presente una queja. No se deben exceder los valores de carga máxima especificados. De lo contrario, el mueble puede dañarse o destruirse.

Antes de colgar o fijar el mueble en el muro (a fin de proteger contra el vuelco del mueble), compruebe de antemano la naturaleza y la resistencia de la pared. Seleccione tacos y tornillos adecuados para el tipo de la pared. En caso de duda, consulte a un especialista, debiendo efectuar este montaje una persona competente. Los muebles que contienen paneles de madera pueden emitir sustancias contaminantes al aire interior. Por lo tanto se recomienda, después de instalar los muebles, ventilar la habitación con frecuencia durante al menos cuatro semanas.

**PT** Antes de iniciar a montagem do móvel, todos os elementos devem ser verificados quanto a danos. Se algum elemento do produto estiver danificado, evite instalar o produto e apresente uma reclamação. Os valores de carga máxima especificados não devem ser excedidos. Caso contrário, o móvel pode ficar danificado ou destruído.

Antes de suspender ou fixar móveis à parede (para evitar quedas), verifique o tipo e a resistência da parede. Seleccione buchas e parafusos adequados ao tipo de parede. Em caso de dúvida contacte um especialista. A instalação deve ser realizada por uma pessoa competente. Os móveis que contenham painéis de madeira podem emitir substâncias poluentes para o ar interior. Assim, recomenda-se, após a instalação dos móveis, ventilar o ambiente frequentemente durante pelo menos quatro semanas.

**RU** Прежде чем приступить к сборке мебели, следует проверить все элементы на предмет повреждений. Если какой-либо элемент продукта поврежден, воздержитесь от установки продукта и подайте жалобу.

Указанные максимальные значения нагрузки превышать нельзя. В противном случае предмет мебели может быть поврежден или разрушен. Прежде чем подвешивать или крепить мебель к стене (во избежание падения), проверьте тип и прочность стены. Выбирайте дюбели и шурупы, подходящие для данного типа стены. В случае сомнений обратитесь к специалисту. Установка должна выполняться компетентным лицом. Мебель, состоящая из древесных плит, может выделять загрязняющие вещества в воздух в помещении. Поэтому рекомендуется после установки мебели часто проветривать помещение в течение как минимум четырех недель.

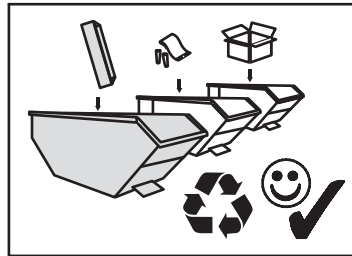
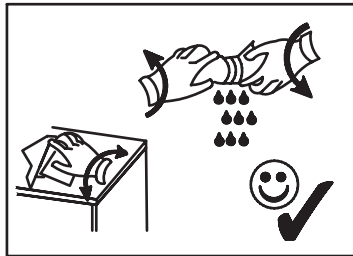
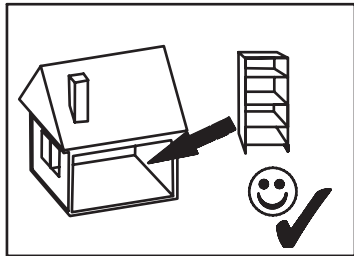
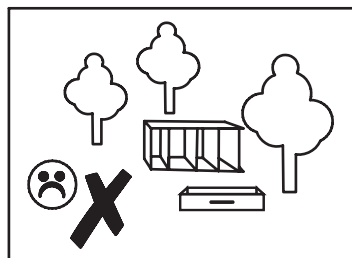
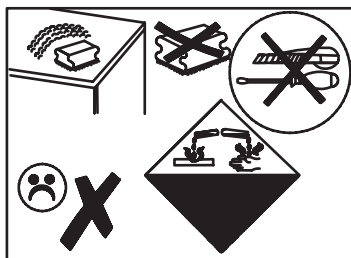
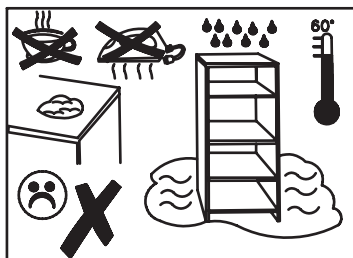
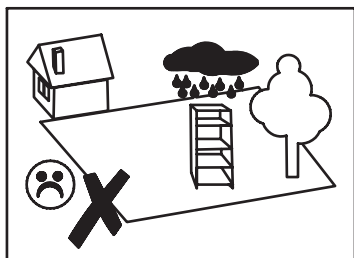



<b>A</b> x30  7x50mm	<b>B</b> x36  8x32mm	<b>DS</b> x12  H=10mm	<b>E</b> x37  3,5x13mm	<b>E2</b> x6  3x20mm	<b>EP1</b> x92  4x16mm	<b>H1</b> x12 	<b>K6</b> x6  L=300mm	<b>M</b> x6  L=150mm
<b>N1</b> x5  20x20 / H=150mm	<b>R</b> x18  H=11mm	<b>T3</b> x48  5x9mm	<b>U</b> x18  L=24,3mm	<b>W1</b> x1 	<b>XA</b> x1 	<b>ZA</b> x30  ∅4	<b>ZR</b> x18  ∅15	

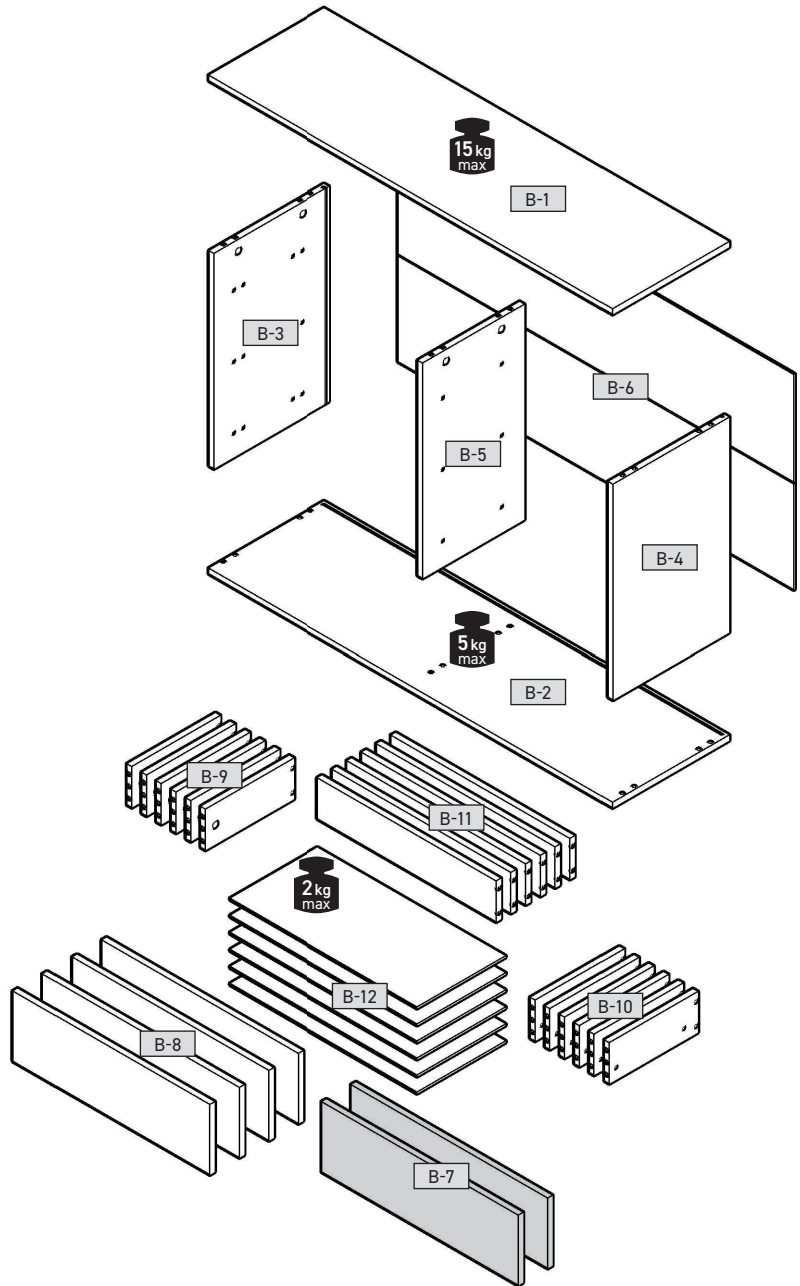

B-1	1373	395	16	x 1	1/2
B-2	1373	395	16	x 1	1/2
B-3	632	394	16	x 1	1/2
B-4	632	394	16	x 1	1/2
B-5	632	345	16	x 1	2/2
B-6	1354	646	3	x 1	1/2
B-7	666	206	16	x 2	2/2
B-8	666	206	16	x 4	2/2
B-9	300	120	16	x 6	1/2
B-10	300	120	16	x 6	1/2
B-11	596	120	16	x 6	1/2
B-12	626	306	3	x 6	1/2

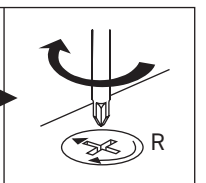
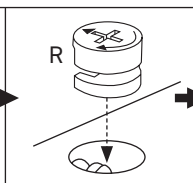
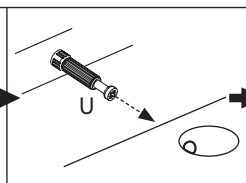
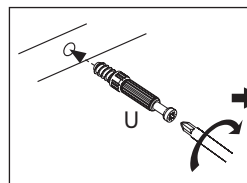
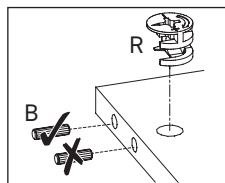
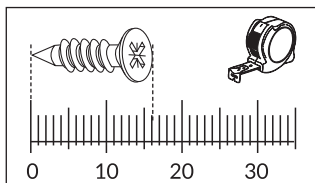



## 1

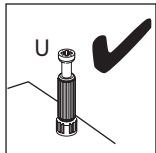
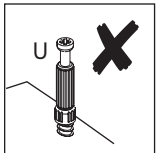
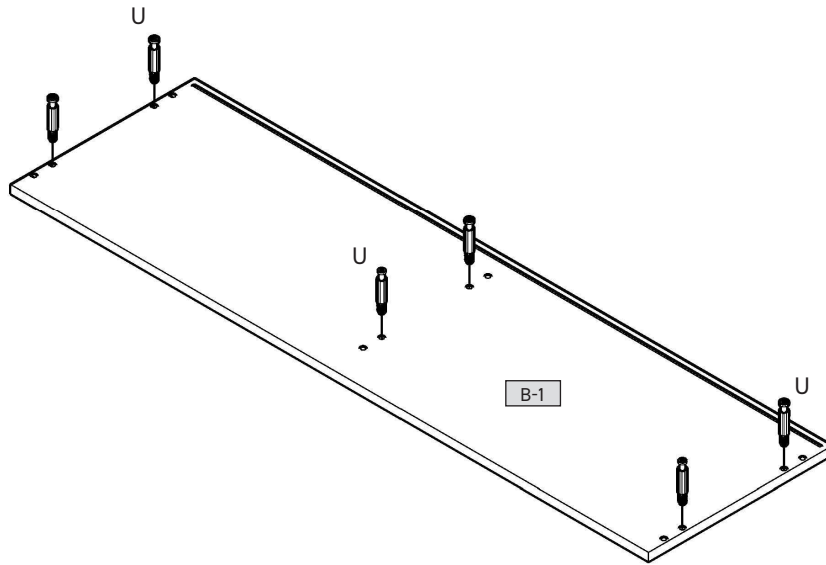
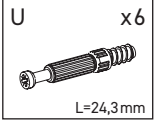

## 2

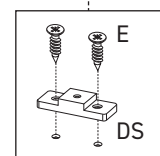
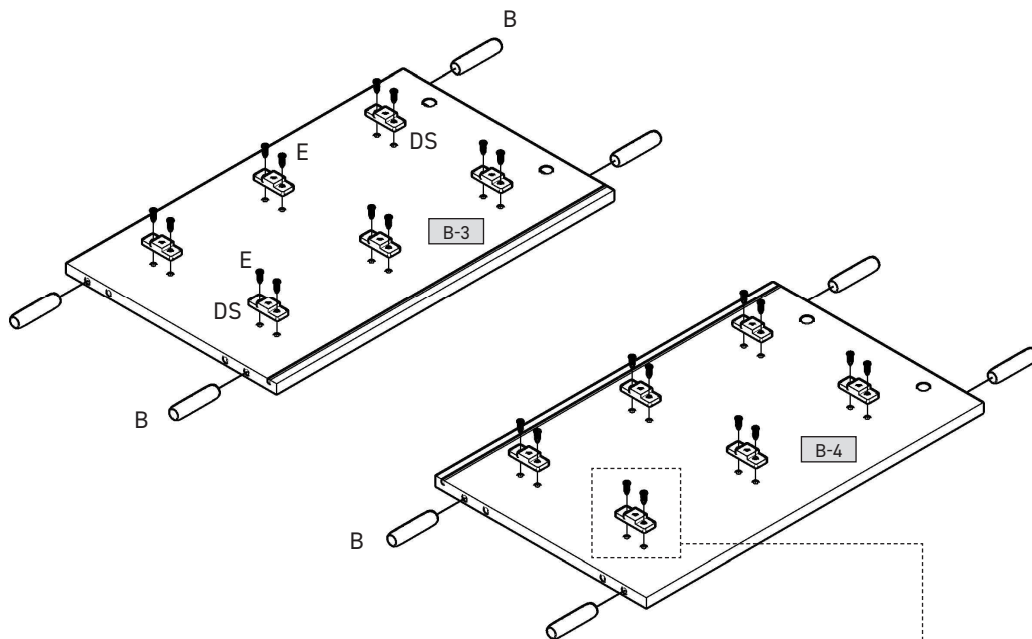
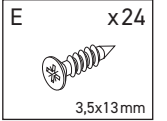
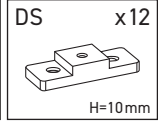
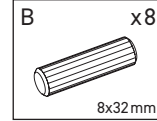



## 3

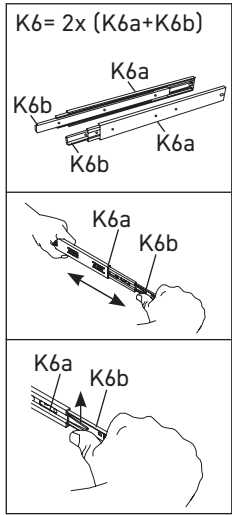
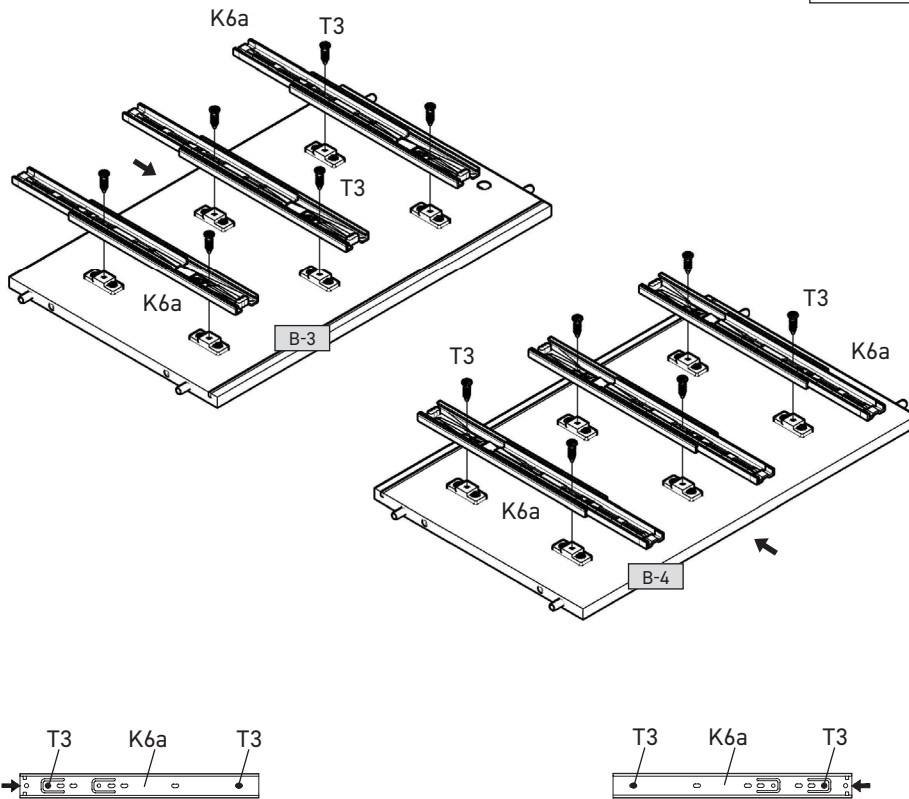
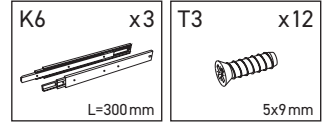

## 4

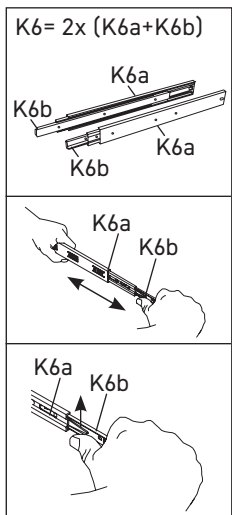
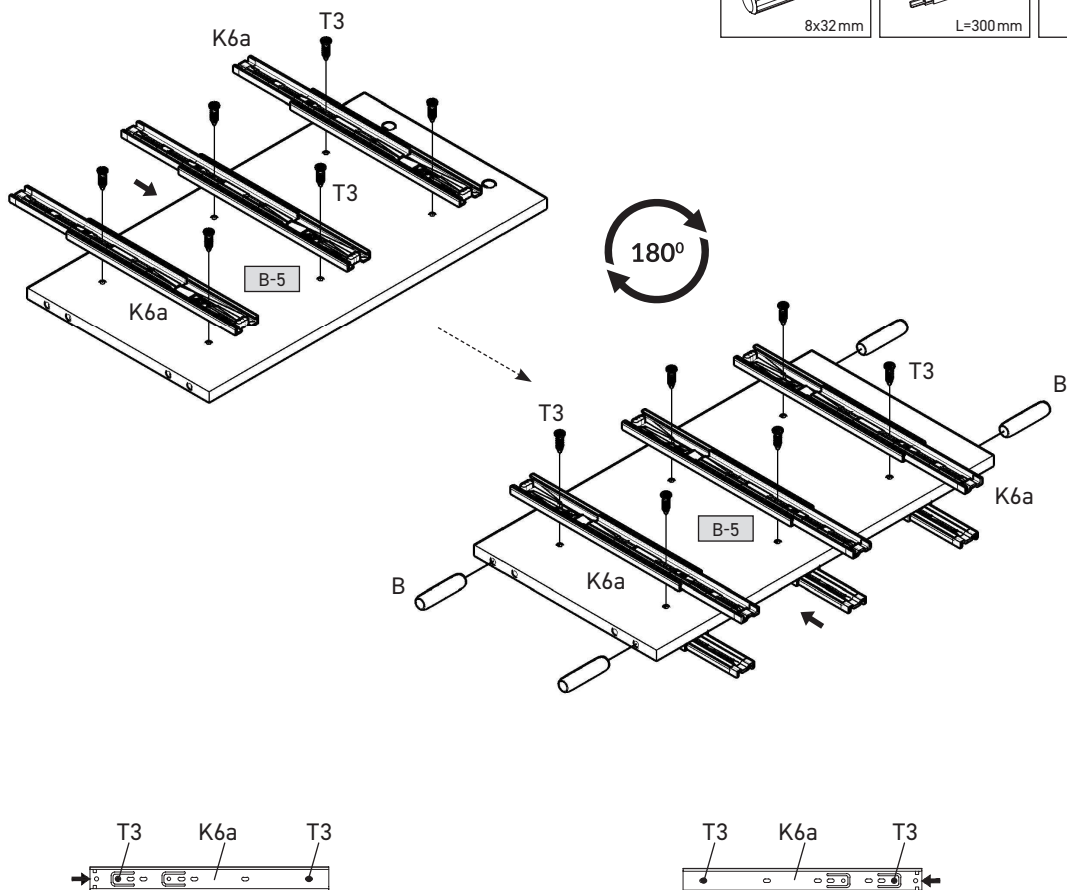
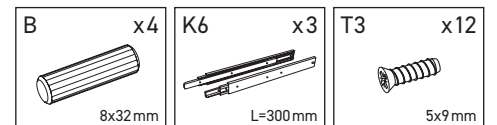



## 5

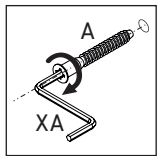
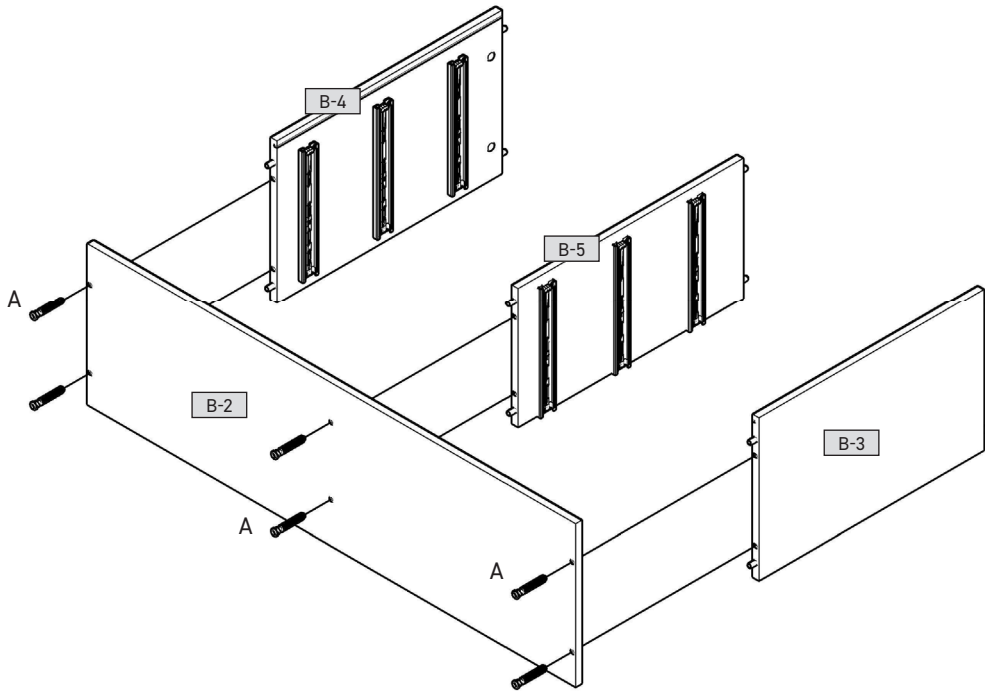
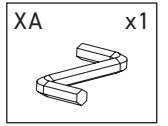
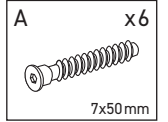

## 6

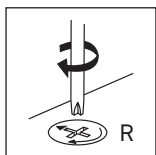
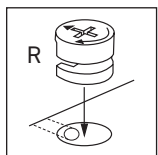
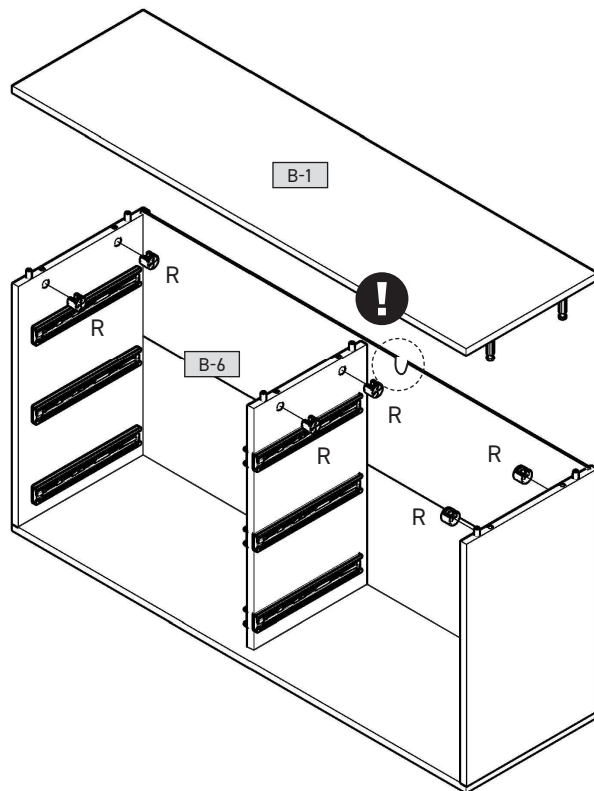
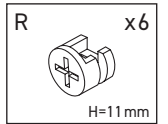

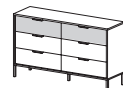

## 7

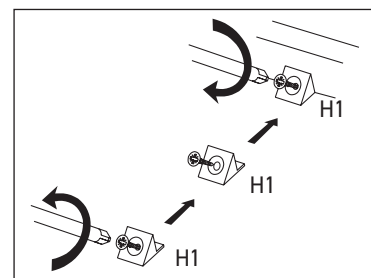
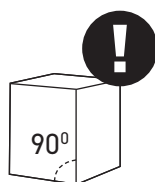
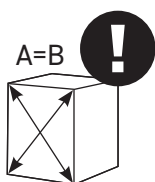
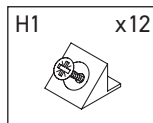
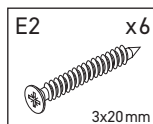
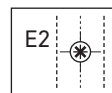
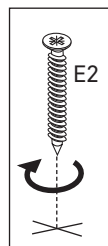
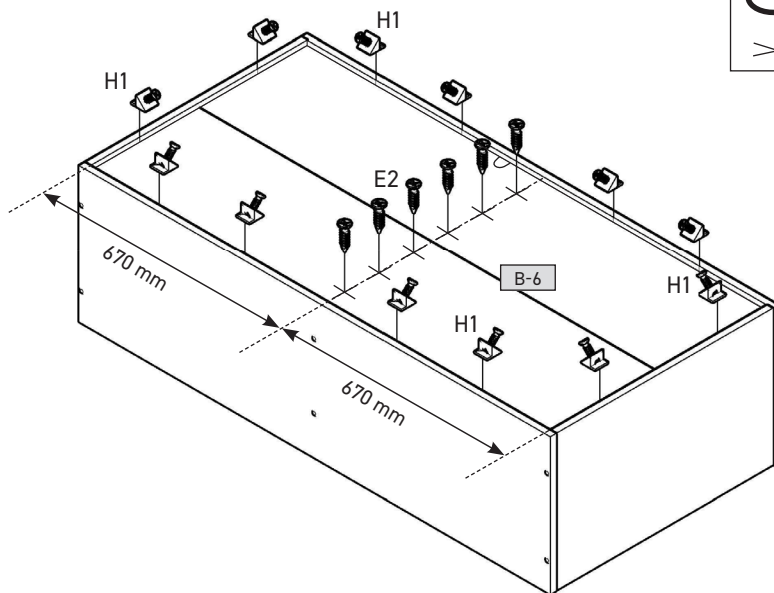
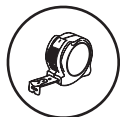

## 8

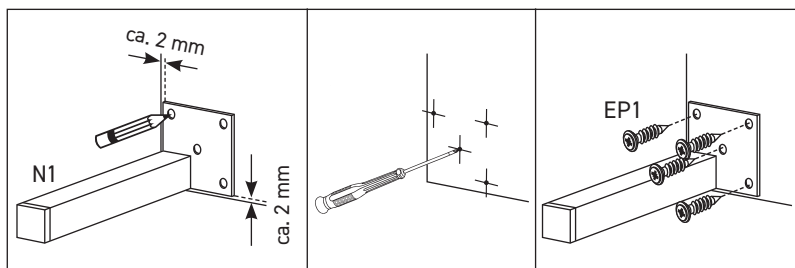
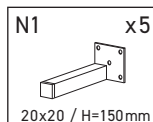
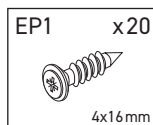
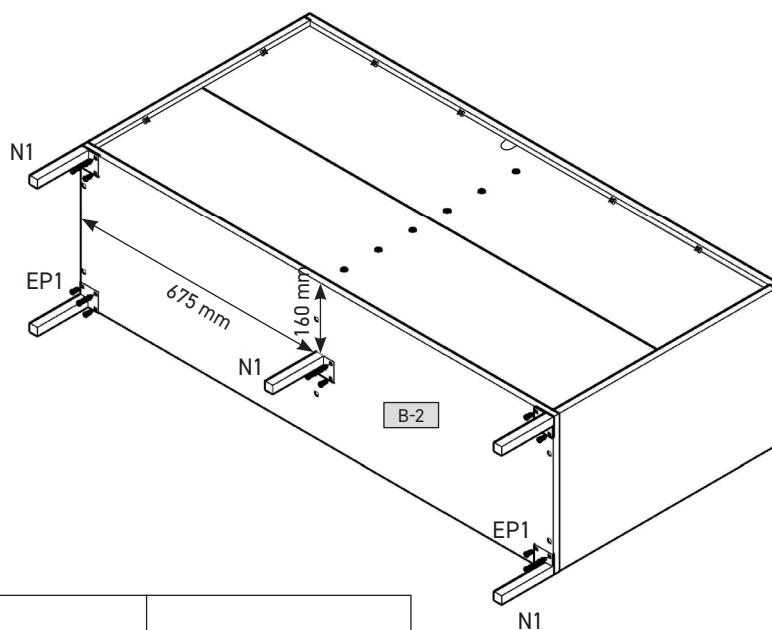



## 9

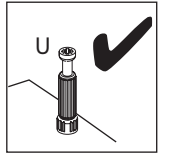
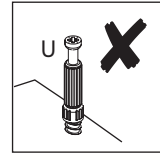
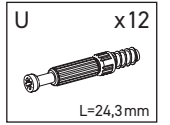
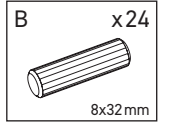
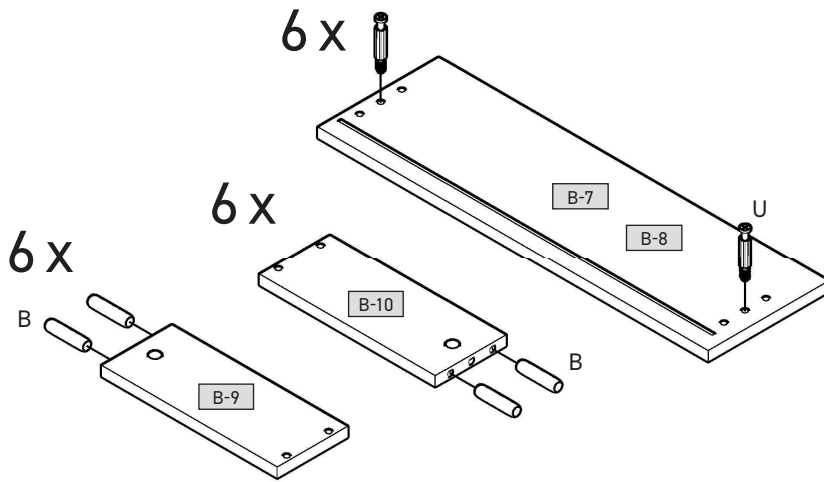

## 10

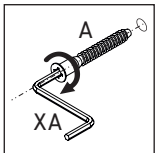
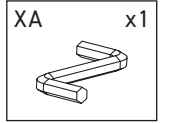
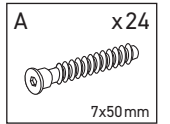
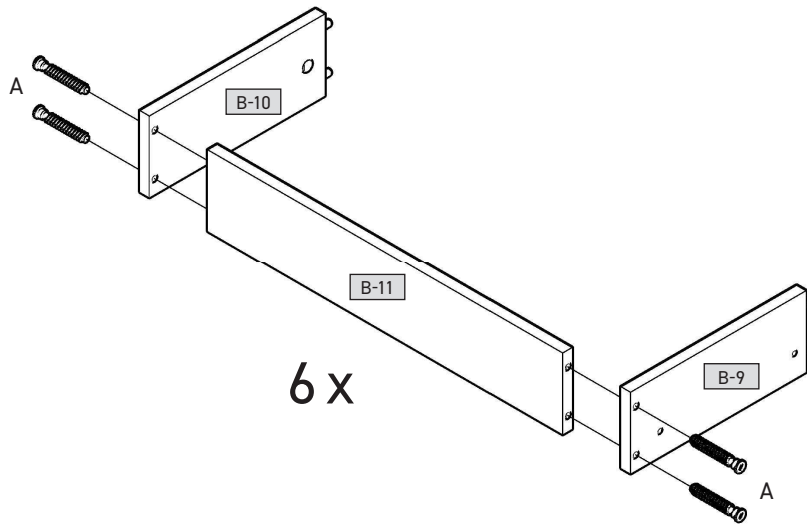

## 11

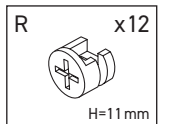
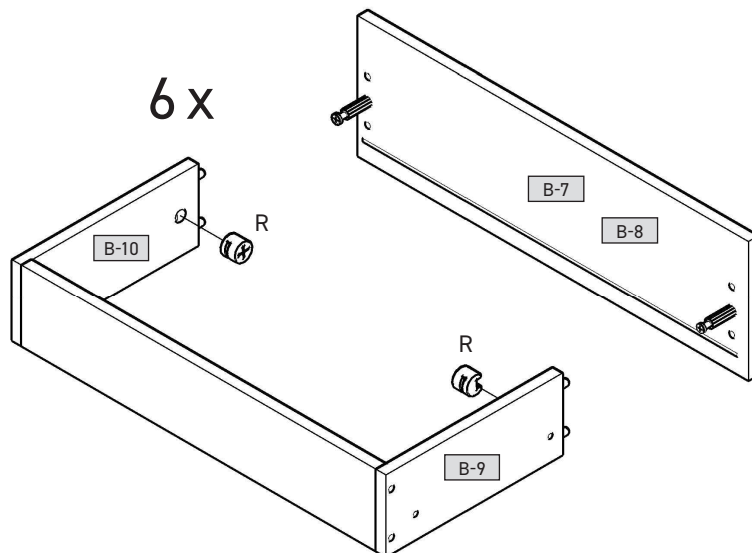
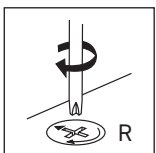
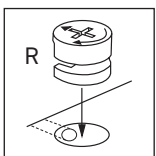

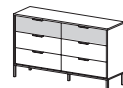

12

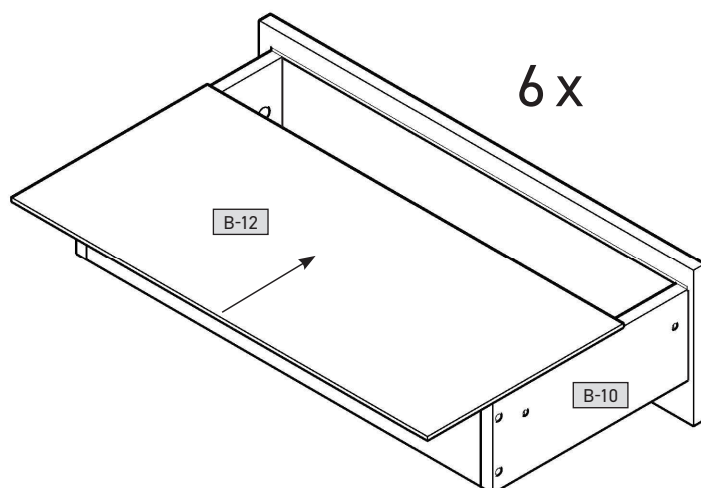

13

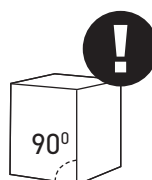
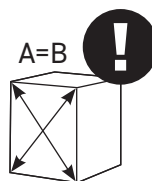
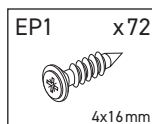
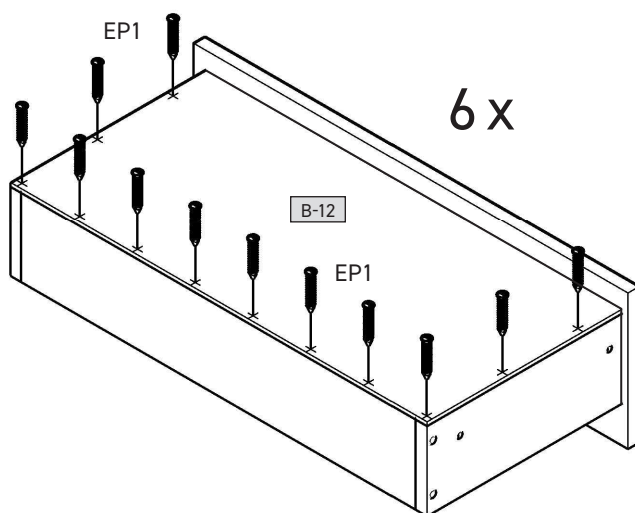
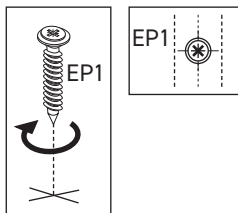
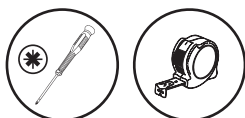

14

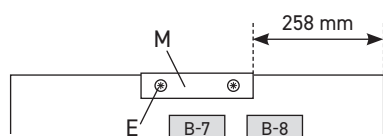
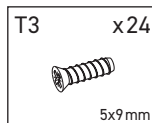
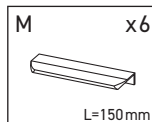
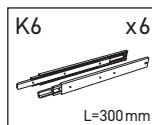
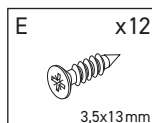
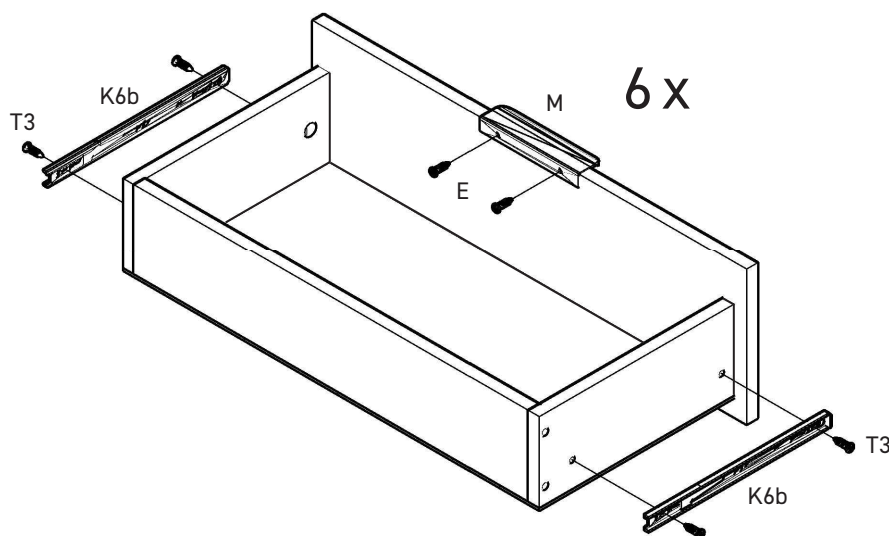
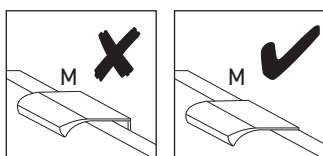
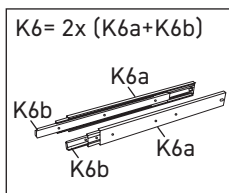



## 15

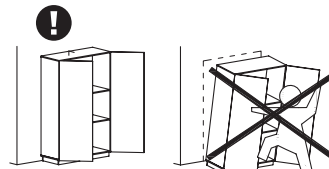
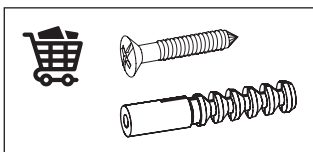
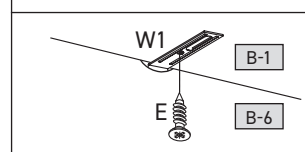
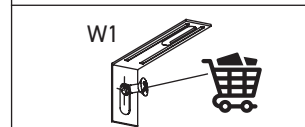
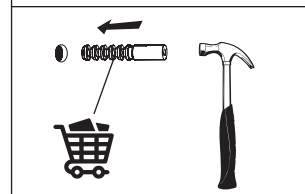
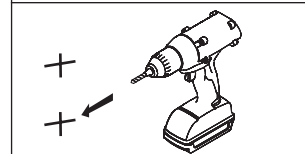
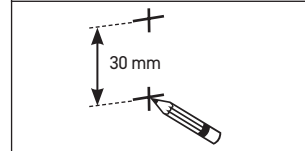
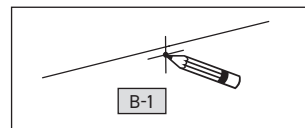
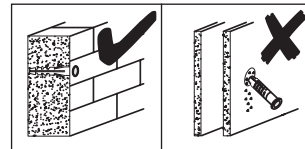
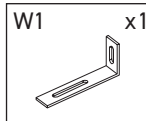
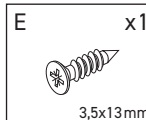
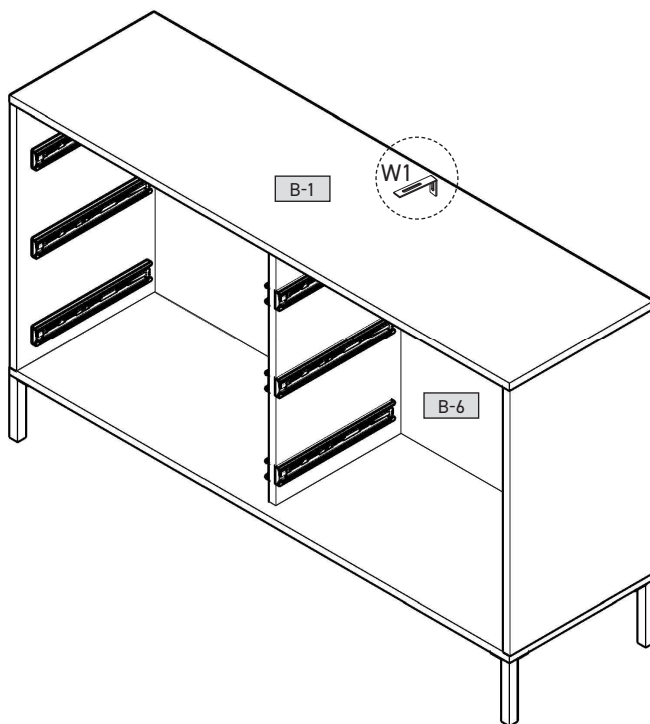
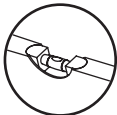

## 16

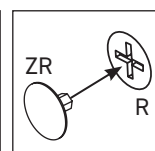
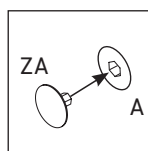
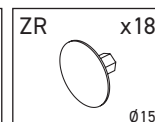
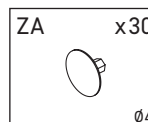
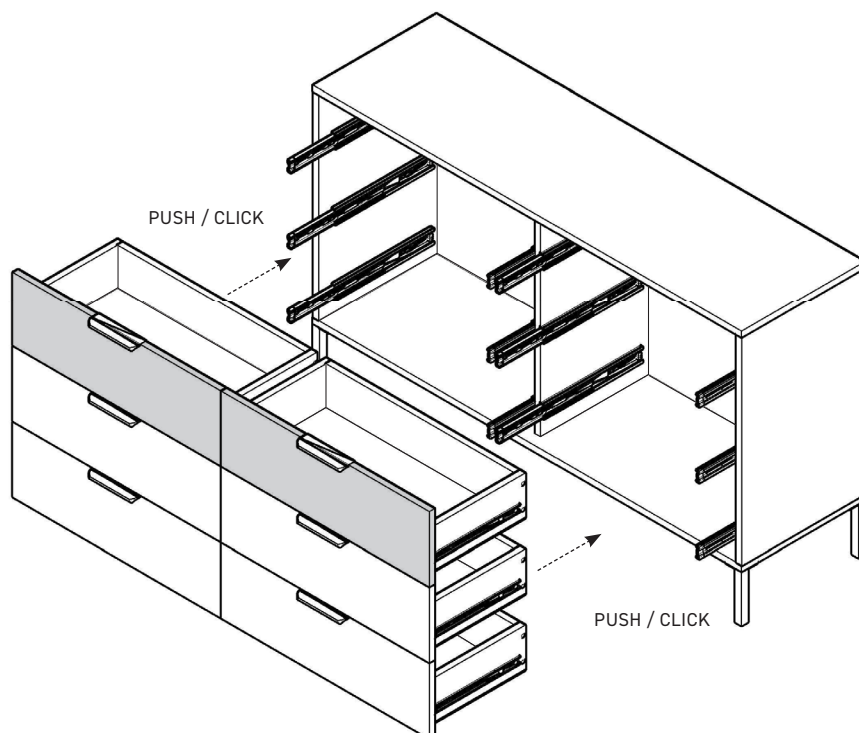

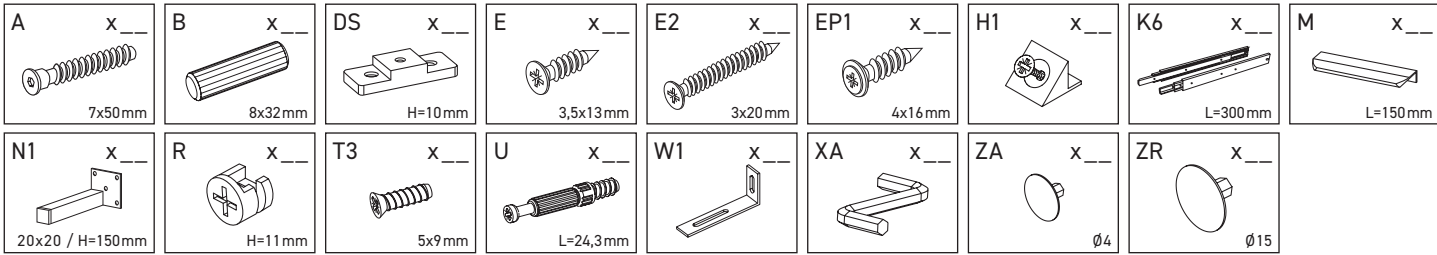

B-1	1373	395	16	x 1	1/2
B-2	1373	395	16	x 1	1/2
B-3	632	394	16	x 1	1/2
B-4	632	394	16	x 1	1/2
B-5	632	345	16	x 1	2/2
B-6	1354	646	3	x 1	1/2
B-7	666	206	16	x 2	2/2
B-8	666	206	16	x 4	2/2
B-9	300	120	16	x 6	1/2
B-10	300	120	16	x 6	1/2
B-11	596	120	16	x 6	1/2
B-12	626	306	3	x 6	1/2

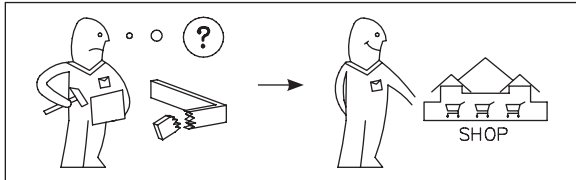
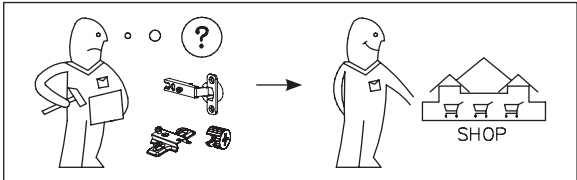
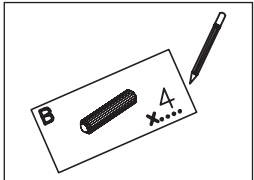
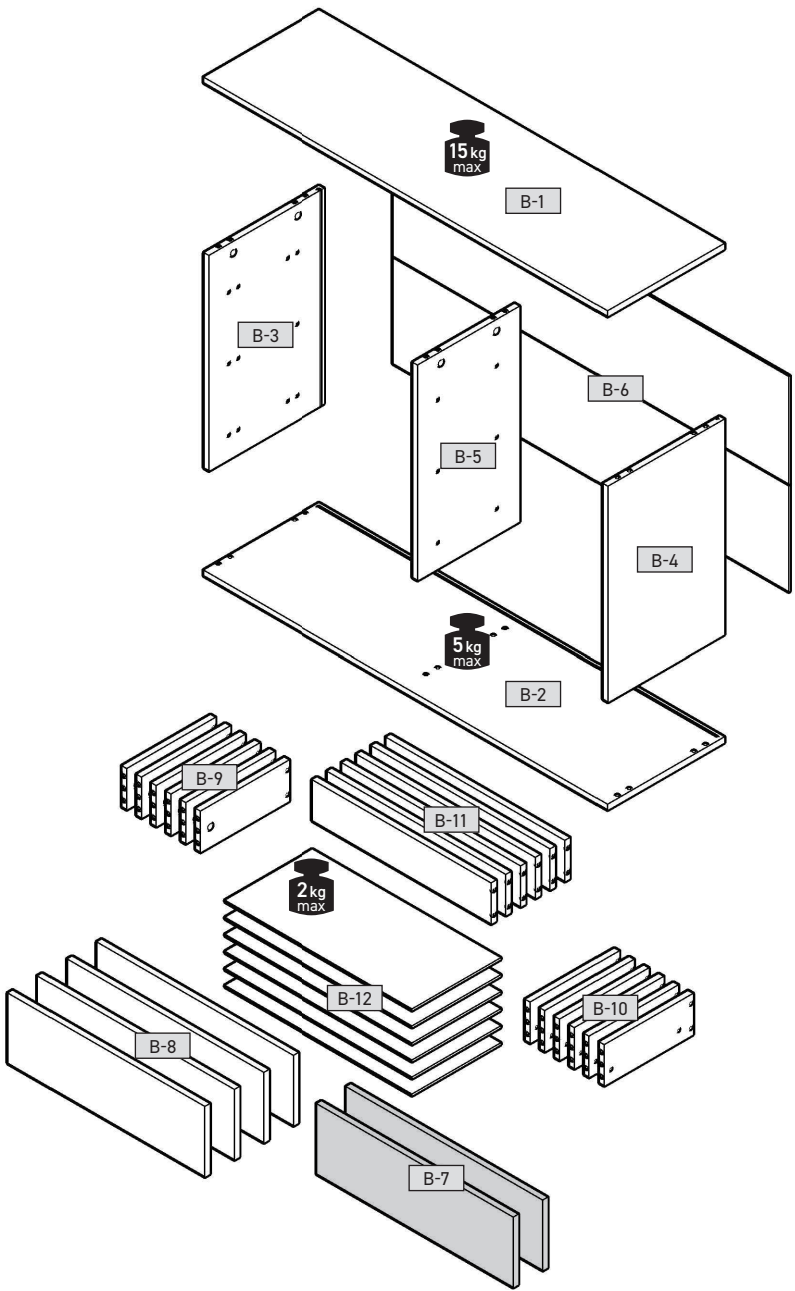











Uwaga - Upozornění - Achtung - Attention - Caution - Figyelem  
 Attenzione - Opgelet - Atenție - Upozornenie - Dikkat

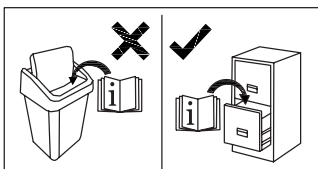
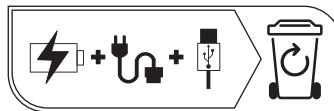
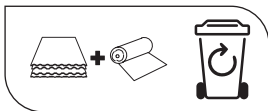
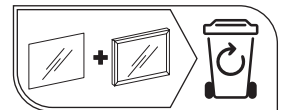
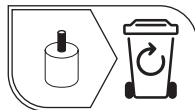
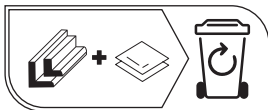
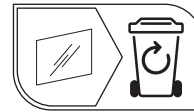
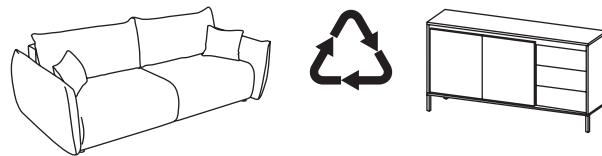
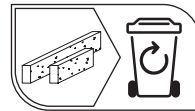
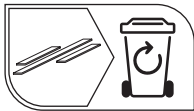
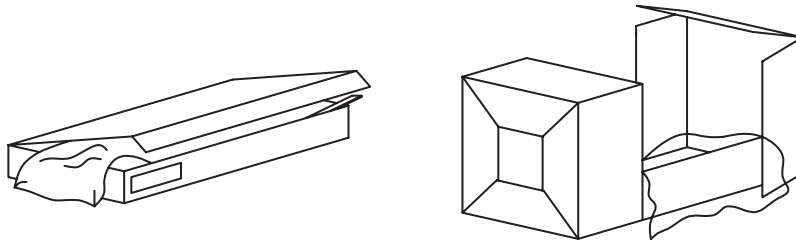

Producent - Produzent - Üretici - Producteur - Výrobce -  
 Termelő - Produser - Produttore - Producător - Productor

**MEBLE LASKI KACZOROWSKA SP.K.**

Laski, ul. Kępińska 21, 63-620 Trzcinica  
 meble-laski@meble-laski.com.pl



Uwaga - Upozornění - Achtung - Attention - Caution - Figyelem  
 Attenzione - Opgelet - Atenție - Upozornenie - Dikkat

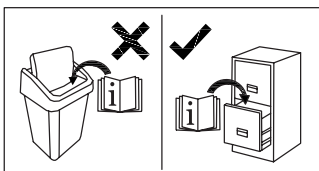
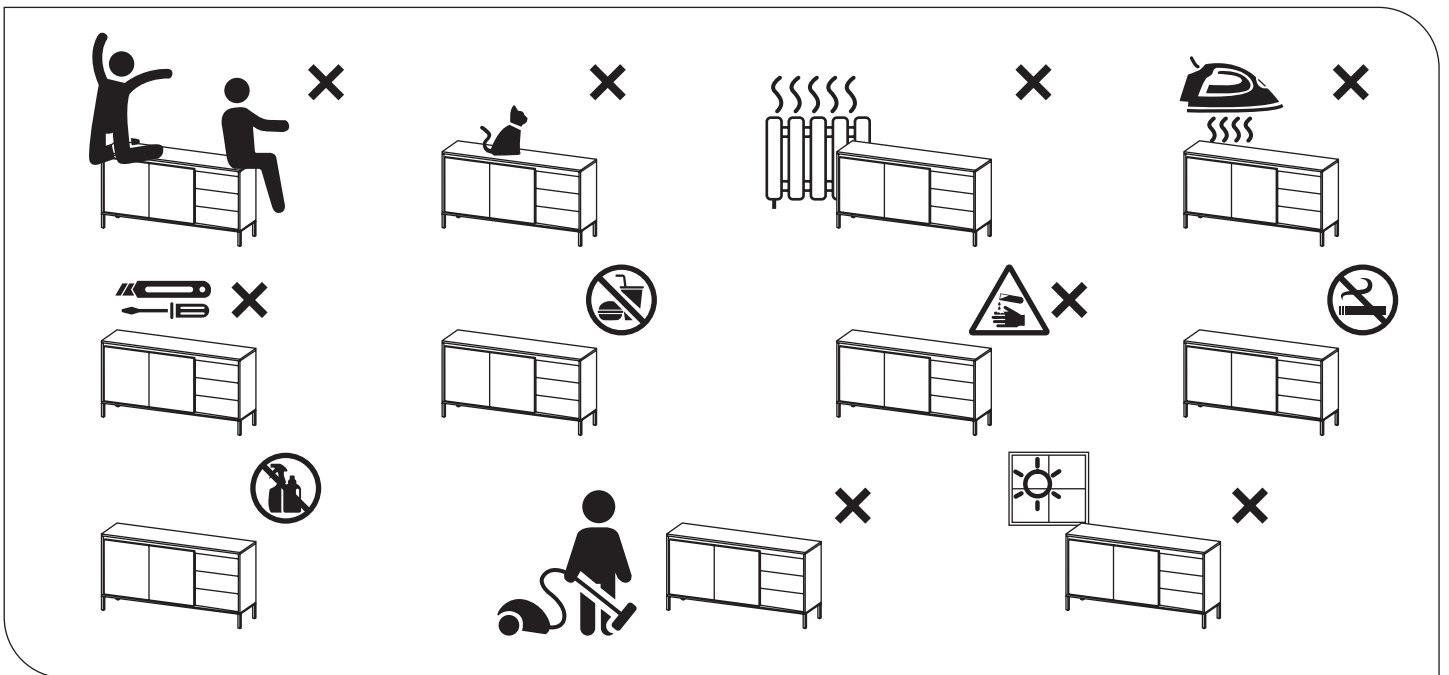
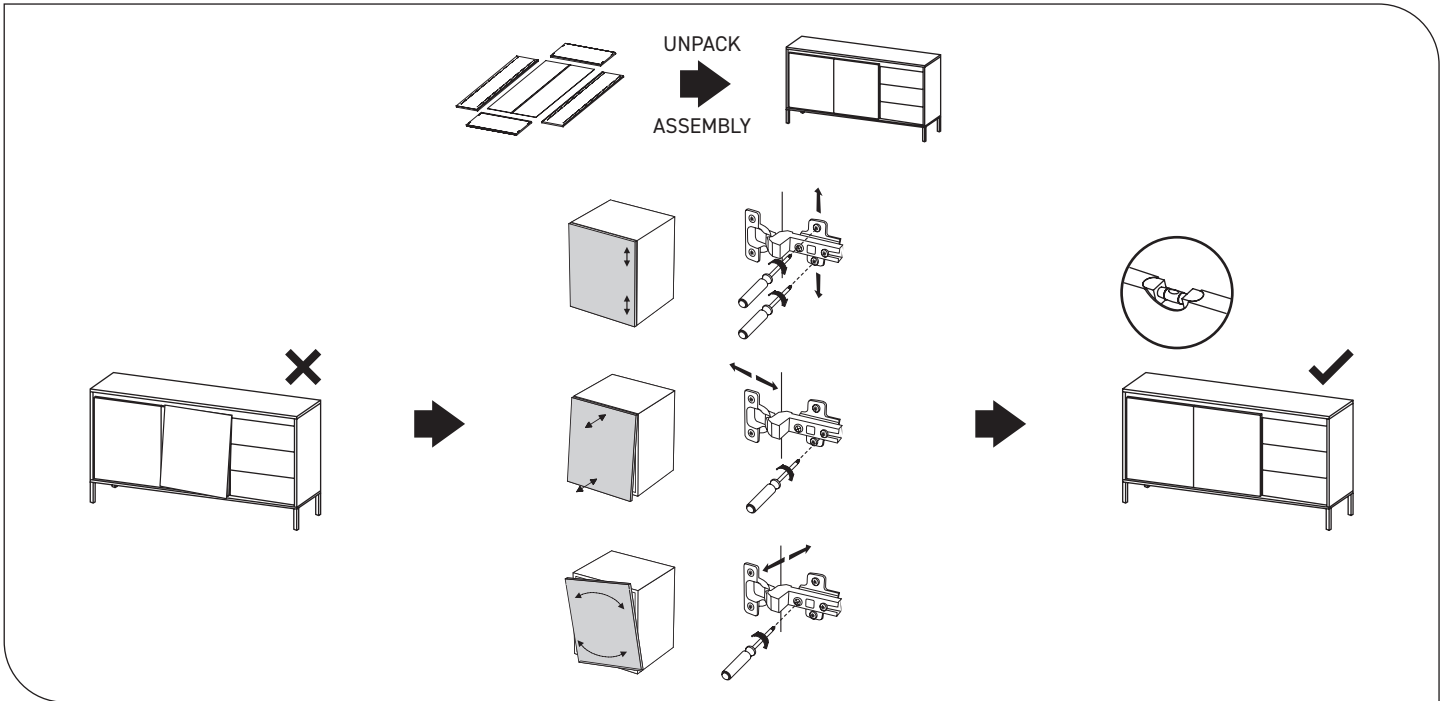
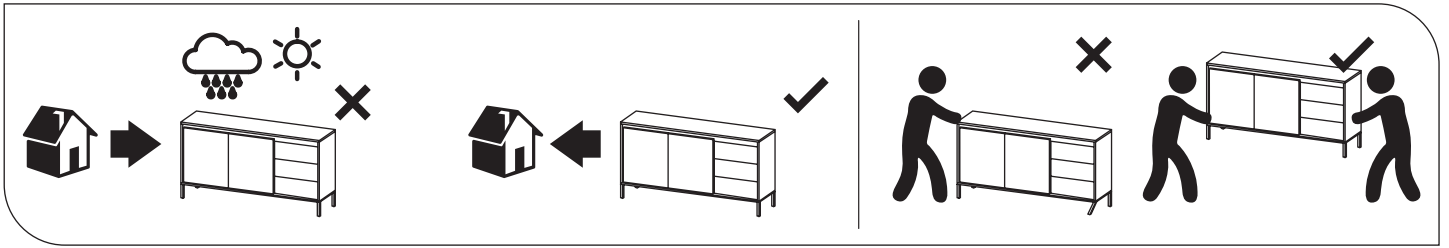

Producent - Produzent - Üretici - Producteur - Výrobce -  
 Termelő - Producer - Produttore - Producător - Productor

**MEBLE LASKI KACZOROWSKA SP.K.**  
 Laski, ul. Kępińska 21, 63-620 Trzcinica  
 meble-laski@meble-laski.com.pl