

XELO - G

PL Instrukcja montażu
 DE Montageanleitung
 NL Handleiding voor de montage
 TR Montaj talimatı
 FR Notice de montage
 CZ Montážní návod
 HU Szerelési útmutató
 GB Assembly instructions
 RU Инструкция по монтажу
 IT Istruzioni di montaggio
 SK Návod na montáž
 RO Instrucțiuni de montaj
 ES Instrucciones de montaje
 PT Instruções de montagem

Producent - Produzent - Üretici - Producteur - Výrobce -
 Termelő - Producer - Produttore - Producător - Productor
MEBLE LASKI KACZOROWSKA SP.K.
 Laski, ul. Kępińska 21, 63-620 Trzcinica
 meble-laski@meble-laski.com.pl

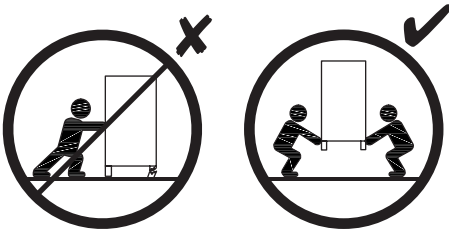
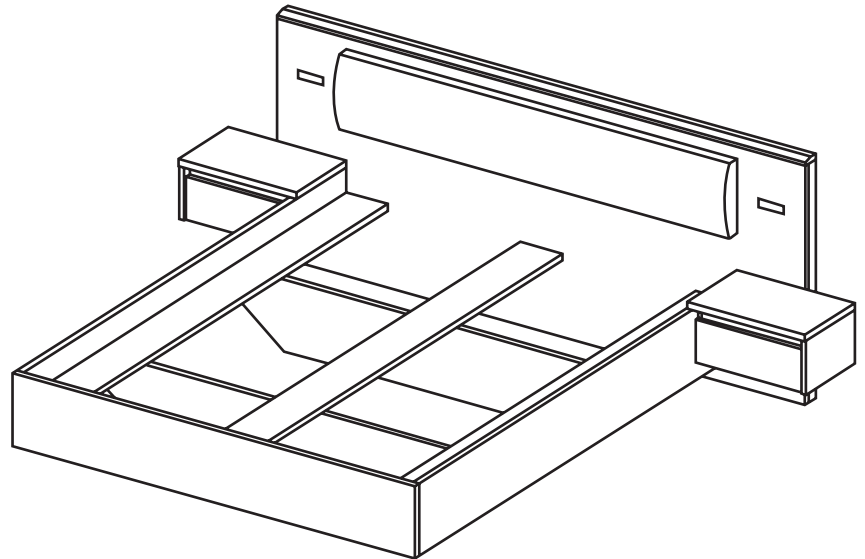

2025-01-03

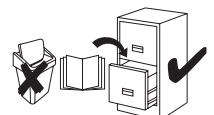
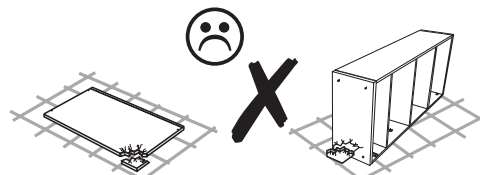
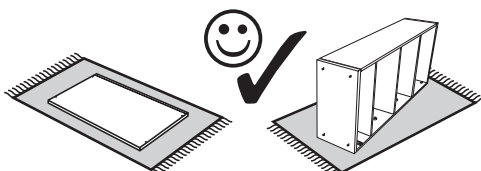
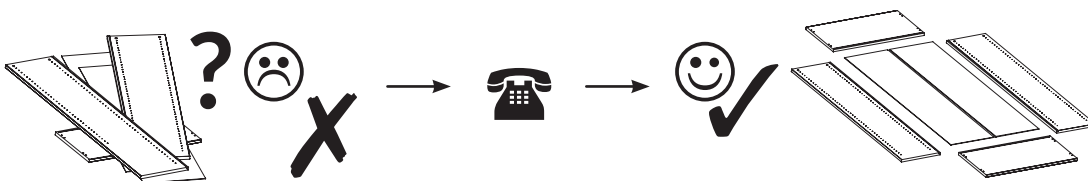
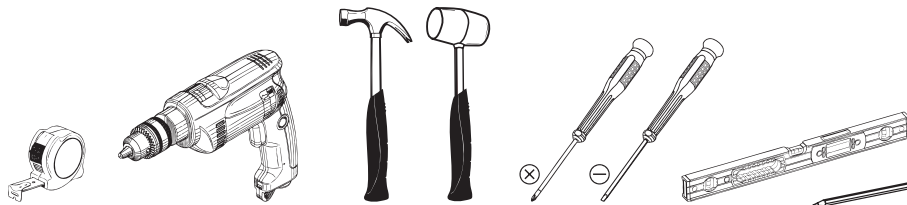



PL Przed rozpoczęciem montażu mebla wszystkie elementy należy sprawdzić czy nie są uszkodzone. W przypadku wykrycia uszkodzenia elementu należy odstąpić od montażu mebla i złożyć reklamację.

Nie wolno przekraczać podanych maksymalnych wartości obciążenia. W innym przypadku można mebel uszkodzić lub zniszczyć.

Przed zawieszeniem mebla, lub przymocowaniem go do ściany (w celu zabezpieczenia przed przewróceniem), sprawdź wczesniej rodzaj i wytrzymałość ściany. Dobierz odpowiednie kołki i wkręty do rodzaju ściany. W przypadku wątpliwości skontaktuj się ze specjalistą. Montaż musi zostać wykonany przez osobę kompetentną.

Meble zawierające płyty drewnopochodne mogą emitować substancje zanieczyszczające do powietrza w pomieszczeniu. Dlatego zaleca się, po zamontowaniu mebli, częste wentrowanie pomieszczenia przez co najmniej cztery tygodnie.

DE Vor Beginn der Möbelmontage sollten alle Elemente auf Beschädigungen überprüft werden. Wenn ein Element des Produkts beschädigt ist, installieren Sie das Produkt bitte nicht und reichen Sie eine Beschwerde ein. Überschritten Sie die angegebenen Maximalbelastungen nicht. Andernfalls kann das Möbelstück beschädigt oder zerstört werden.

Bevor Sie ein Möbelstück an einer Wand aufhängen oder befestigen (um es gegen Umkippen zu sichern), prüfen Sie Art und Tragfähigkeit der Wand. Wählen Sie für die Wand geeigneten Dübel und Schrauben. Im Zweifelsfall kontaktieren Sie bitte einen Fachmann. Die Montage muss durch eine sachkundige Person ausgeführt werden.

Möbel mit Holzwerkstoffplatten können Schadstoffe in die Raumluft abgeben, daher Es wird empfohlen, den Raum nach dem Einbau der Möbel mindestens vier Wochen lang häufig zu lüften.

FR Avant de commencer l'assemblage du meuble, tous les éléments doivent être vérifiés pour détecter tout dommage. Si un élément du produit est endommagé, veuillez ne pas installer le produit et déposer une plainte.

Ne dépassez pas les charges maximum indiquées. Sinon, le meuble peut être endommagé ou détruit.

Avant de suspendre le meuble ou de le fixer au mur (dans le but d'éviter un renversement), vérifiez au préalable le type et la résistance du mur. Utilisez les chevilles et les vis adaptées au type de mur. En cas de doute, veuillez contacter un spécialiste. Le montage doit être réalisé par une personne compétente.

Les meubles contenant des panneaux à base de bois peuvent émettre des substances polluantes dans l'air intérieur. Donc Il est recommandé, après l'installation des meubles, d'aérer fréquemment la pièce pendant au moins quatre semaines.

CZ Před zahájením montáže nábytku je třeba zkontrolovat poškození všech prvků. Pokud je některý prvek produktu poškozen, zdržte se instalace produktu a podějte stížnost.

Nepřekračujte uvedená maximální zatížení. V opačném případě může dojít k poškození nebo zničení nábytku.

Před zavěšením nábytku nebo jeho připevněním ke zdi (za účelem zajištění před převrácením) dřve zkontrolujte druh a odolnost stěny. Vyberte k druhu stěny vhodné hmoždinky a šrouby. V případě pochybností kontaktujte specialistu. Montáž musí být provedena kompetentní osobou.

Nábytek obsahující panely na bázi dřeva může uvolňovat znečišťující látky do vnitřního ovzduší. Proto doporučuje se po instalaci nábytku místnost pravidelně větrat po dobu nejméně čtyř týdnů.

HU A bútorszerelés megkezdése előtt ellenőrizni kell az összes elem sérülését. Ha a termék bármely eleme megsérült, kérjük, tartózkodjon a termék telepítésétől és nyújtson be panaszt.

A megadott maximális terhelési értékeket nem szabad túllépni. Ellenkező esetben a bútort megsérülhet vagy megsemmisülhet.

A bútort felüggesztése illetve falhoz való rögzítése (megakadályozván ezzel eldőlésének lehetőségét) előtt ellenőrizze a fal fajtáját és szilárdságát. Megfelelő, a falhoz illő tüpliket és csavarokat használjon. Ha kétsége támadna, konzultáljon szakemberrel. A felszerelést csak egy hozzáértő szakember végezheti el.

A fa alapú paneleket tartalmazó bútork szennyező anyagokat bocsáthatnak ki a beltéri levegőbe. Ezért Ajánlott a bútork beszerelése után legalább négy hétig rendszeresen szellőztetni a helyiséget.

GB Before starting the furniture assembly, all elements should be checked for damage. If any element of the product is damaged, please refrain from installing the product and file a complaint.

The specified maximum load values must not be exceeded. Otherwise, the piece of furniture may be damaged or destroyed.

Before suspending or fixing furniture to the wall (in order to prevent falling over), check the type and strength of the wall. Select wall plugs and screws appropriate for the given type of wall. In the case of doubts, contact a specialist. The installation must be performed by a competent person.

Furniture containing wood-based panels can emit polluting substances into the indoor air. Therefore recommended, after installing the furniture, to ventilate the room frequently for at least four weeks.

SK Pred začatím montáže nábytku by sa mali skontrolovať všetky prvky, či nie sú poškodené. Ak je niektorý prvok výrobku poškodený, neinštalujte výrobok a reklamujte ho.

Uvedené hodnoty maximálneho zaťaženia nesmú byť prekročené. V opačnom prípade môže dôjsť k poškodeniu alebo zničeniu nábytku.

Pred zavesením nábytku alebo jeho pripavením na stenu (za účelom zaistenia pred prevrátením) predtým skontrolujte druh a odolnosť steny. Vyberte k druhu steny vhodné hmoždinky a skrutky. V prípade pochybností kontaktujte špecialistu. Montáž musí byť vykonaná kompetentnou osobou.

Nábytek obsahujúci dosky na báze dreva môže vylučovať znečisťujúce látky do vnútorného ovzdušia. Preto odporúča sa po instalácii nábytku miestnosť pravidelne vetrať aspoň štyri týždne.

IT Prima di iniziare l'assemblaggio del mobile, tutti gli elementi dovrebbero essere controllati per danni. Se qualche elemento del prodotto è danneggiato, astenersi dall'installare il prodotto e presentare un reclamo.

I valori di carico massimo specificati non devono essere superati. In caso contrario, il mobile potrebbe essere danneggiato o distrutto.

Prima di appendere i mobili, oppure attaccarli al muro (per proteggerli da ribaltamenti), verifica prima la tipologia e resistenza del muro. Scegli i tasselli e viti più adatti per il tipo di muro. In caso di dubbi contattare uno specialista. Il montaggio deve essere fatto da una persona competente.

I mobili contenenti pannelli a base di legno possono emettere sostanze inquinanti nell'aria interna. Perciò si consiglia, dopo aver installato i mobili, di aereare frequentemente il locale per almeno quattro settimane.

NL Voordat u met de meubelmontage begint, moeten alle elementen op schade worden gecontroleerd. Als een onderdeel van het product beschadigd is, installeer het dan niet en dien een klacht in.

Belirtilen azami yuk degerini asmayiniz, aksi takdirde mobilya parçasi zarar gorebilir veya kullanilamazeyeze gelebilir.

Voordat u het meubel ophangt of bevestigt tegen de muur (om het te beschermen tegen omvallen) dient u het type en de duurzaamheid van deze muur na te kijken. Maak gebruik van pluggen en schroeven die geschikt zijn voor het type muur. Neem in geval van twijfels contact op met een specialist. De assemblage dient te worden uitgevoerd door iemand met kennis van zaken.

Meubels met panelen of houtbasis kunnen vervuulende stoffen in de binnenlucht uitstoten. Daarom Het is raadzaam om na het plaatsen van het meubilair de ruimte minimaal vier weken regelmatig te ventileren.

TR Mobilya montajına başlamadan önce tüm elemanlarda hasar olup olmadığını kontrol edilmelidir. Ürünün herhangi bir parçası hasar görmüşse, lütfen ürünü kurmayız ve şikayette bulunun.

Belirtilen azami yük degerini asmayiniz, aksi takdirde mobilya parçasi zarar gorebilir veya kullanilamazeyeze gelebilir.

Mobilyayı duvara asmadan veya montaj etmeden önce (devrilmesini önlemek için) duvarın türünü ve dayanıklılığını kontrol edin. Duvara uygun dübelleri ve vidaları seçin. Emin olamamanız durumunda bir uzman ile iletişime geçin.

Kurulum yetkili bir kişi tarafından yapılmalıdır. Aşşap bazı paneller içeren mobilyalar için mekan havasına kirletici maddeler yayabilir. Öyleyse Mobilyaların kurulumundan sonra odanın en az dört hafta boyunca sık sık havalandırılması önerilir.

RO Înainte de a începe asamblarea mobilierului, toate elementele trebuie verificate pentru a nu se deteriora. Dacă vreun element al produsului este deteriorat, vă rugăm să vă abțineți de la instalarea produsului și să depuneți o reclamație.

Valorile maxime de sarcină specificate nu trebuie depășite. În caz contrar, piesa de mobilier poate fi deteriorată sau distrusă.

Înainte de suspendarea unei piese de mobilier sau atașarea acestuia la perete (pentru a preveni bascularea), verificați în prealabil tipul și gradul de rezistență a peretelui. Montați diblurile și șuruburile adecvate pentru tipul de perete. În caz de îndoieli, consultați un specialist. Instalarea trebuie să fie efectuată de către o persoană competentă.

Mobilierul care conține panouri pe bază de lemn poate emite substanțe poluante în aerul interior. Prin urmare se recomandă ca, după montarea mobilierului, aerisirea frecventă a încăperii timp de cel puțin patru săptămâni.

ES Antes de comenzar el montaje de los muebles, todos los elementos deben comprobarse en busca de daños. Si algún elemento del producto está dañado, absténgase de instalar el producto y presente una queja.

No se deben exceder los valores de carga máxima especificados. De lo contrario, el mueble puede dañarse o destruirse.

Antes de colgar o fijar el mueble en el muro (a fin de proteger contra el vuelco del mueble), compruebe de antemano la naturaleza y la resistencia de la pared. Seleccione tacos y tornillos adecuados para el tipo de la pared. En caso de duda, consulte a un especialista, debiendo efectuar este montaje una persona competente.

Los muebles que contienen paneles de madera pueden emitir sustancias contaminantes al aire interior. Por lo tanto Se recomienda, después de instalar los muebles, ventilar la habitación con frecuencia durante al menos cuatro semanas.

PT Antes de iniciar a montagem do móvel, todos os elementos devem ser verificados quanto a danos. Se algum elemento do produto estiver danificado, evite instalar o produto e apresente uma reclamação.

Os valores de carga máxima especificados não devem ser excedidos. Caso contrário, o móvel pode ficar danificado ou destruído.

Antes de suspender ou fixar móveis à parede (para evitar quedas), verifique o tipo e a resistência da parede. Seleccione buchas e parafusos adequados ao tipo de parede. Em caso de dúvida contacte um especialista. A instalação deve ser realizada por uma pessoa competente.

Os móveis que contenham painéis de madeira podem emitir substâncias poluentes para o ar interior. Assim, recomendamos-se, após a instalação dos móveis, ventilar o ambiente frequentemente durante pelo menos quatro semanas.

RU Прежде чем приступить к сборке мебели, следует проверить все элементы на предмет повреждений. Если какой-либо элемент продукта поврежден, воздержитесь от установки продукта и подайте жалобу.

Указанные максимальные значения нагрузки превышать нельзя. В противном случае предмет мебели может быть поврежден или разрушен.

Прежде чем подвешивать или крепить мебель к стене (во избежание падения), проверьте тип и прочность стены. Выбирайте дюбели и шурупы, подходящие для данного типа стены. В случае сомнений обратитесь к специалисту. Установка должна выполняться компетентным лицом.

Мебель, состоящая из древесных плит, может выделять загрязняющие вещества в воздух в помещении. Поэтому рекомендуется после установки мебели часто проветривать помещение в течение как минимум четырех недель.

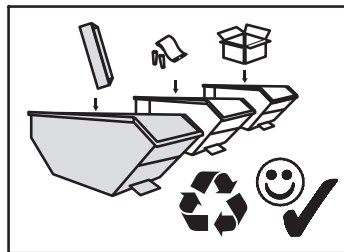
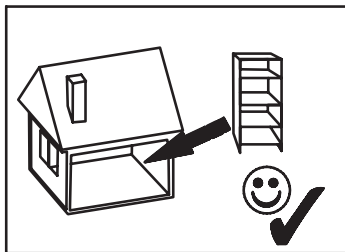
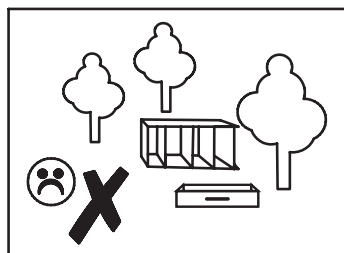
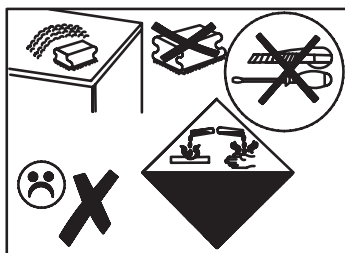
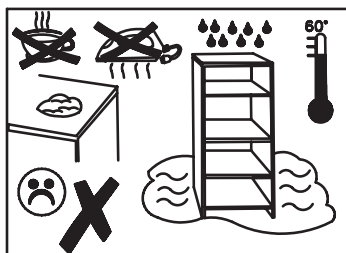
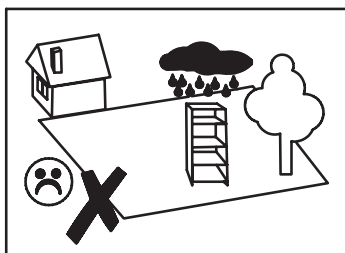

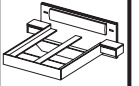

A 7 x 50 mm x 22	B 8 x 32 mm x 68	E2 3 x 20 mm x 18	E5 4 x 16 mm x 24	EM6 6 x 40 mm x 6	G2 x 8
K L=250 mm x 2	R H=11 mm x 30	R1 H=15 mm x 8	RA x 4	RB x 8	RAA x 4
RRB 6 x 55 x 4	T3 5 x 9 mm x 8	U L=24,3 mm x 34	U5 L=22 mm x 4	W9 x 3	XA x 1
ZR Ø 15 x 38	LED x 1				

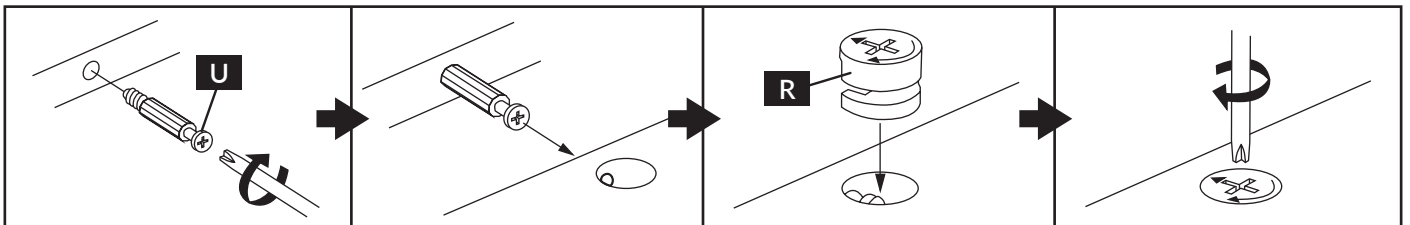
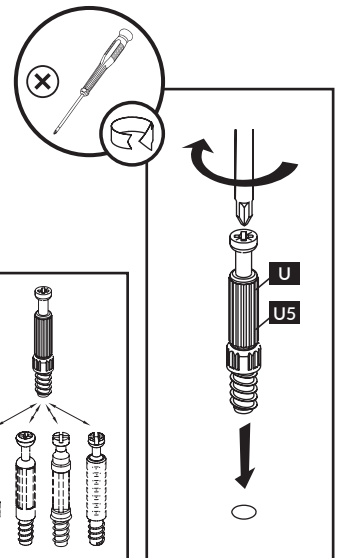
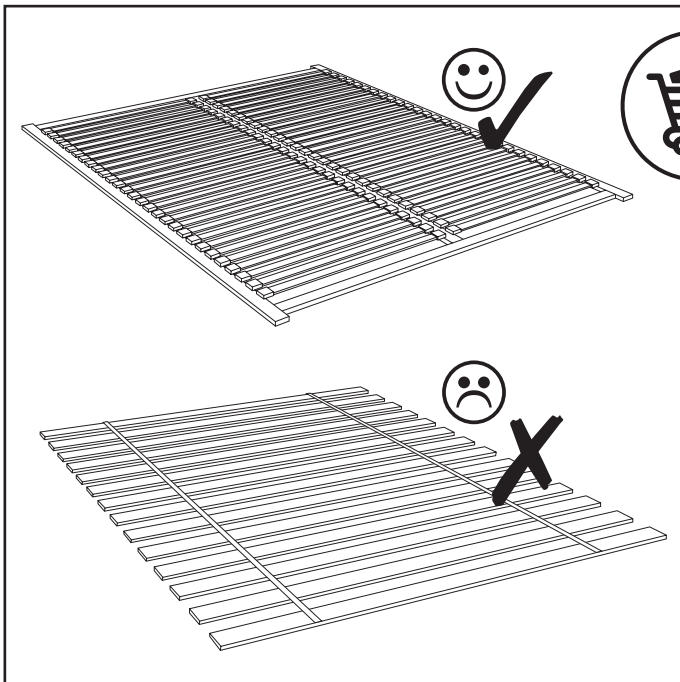
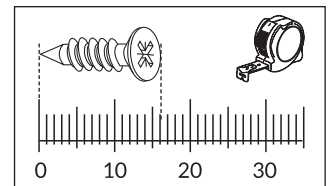

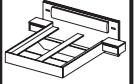

G-1	2158	900	16	x1	1/2
G-2	1644	274	22	x1	2/2
G-3L	2000	270	22	x1	2/2
G-3P	2000	270	22	x1	2/2
G-4	2000	170	16	x3	2/2
G-5	1600	268	22	x2	1/2
G-6	2158	60	18	x1	1/2
G-7	900	44	16	x4	2/2
G-8	1600	280	75	x1	2/2
G-9L	480	305	22	x1	1/2
G-9P	480	305	22	x1	1/2
G-10	426	275	16	x2	1/2

G-11L	426	186	16	x1	1/2
G-11P	426	186	16	x1	1/2
G-12	426	60	16	x2	2/2
G-13L	300	203	16	x1	2/2
G-13P	300	203	16	x1	2/2
G-14L	275	203	16	x1	2/2
G-14P	275	203	16	x1	2/2
G-15L	438	162	16	x1	1/2
G-15P	438	162	16	x1	1/2
G-16	372	100	16	x2	2/2
G-17	250	100	16	x2	2/2
G-18	250	100	16	x2	2/2
G-19	403	257	3	x2	1/2

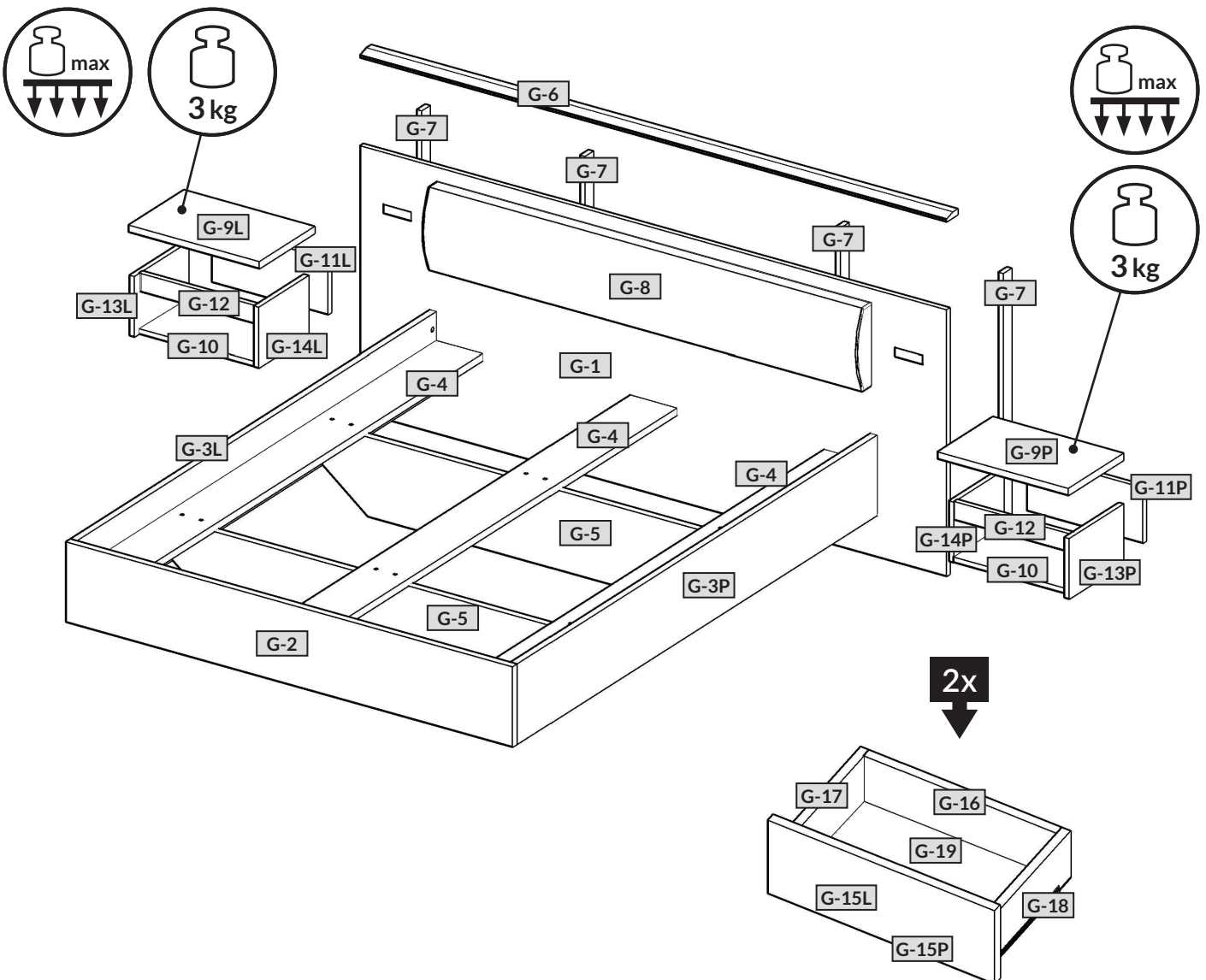

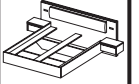

1

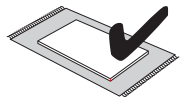
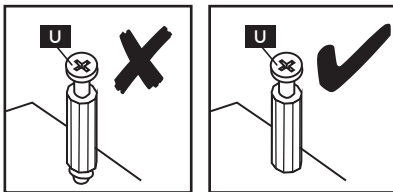
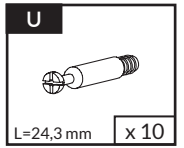
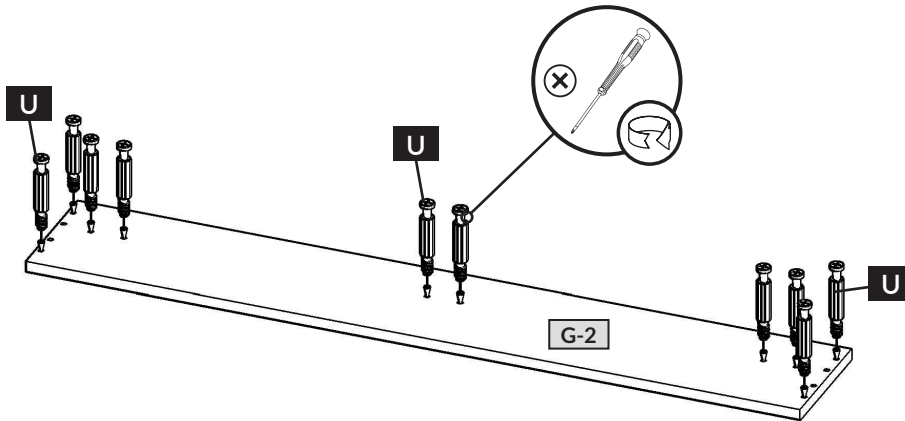

2

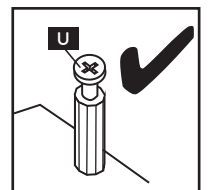
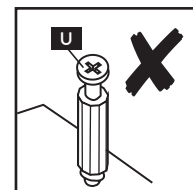
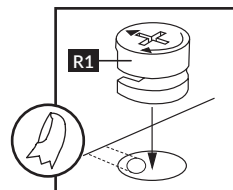
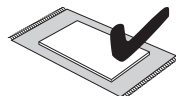
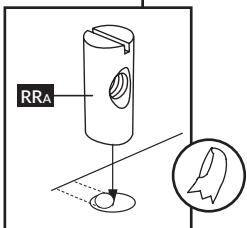
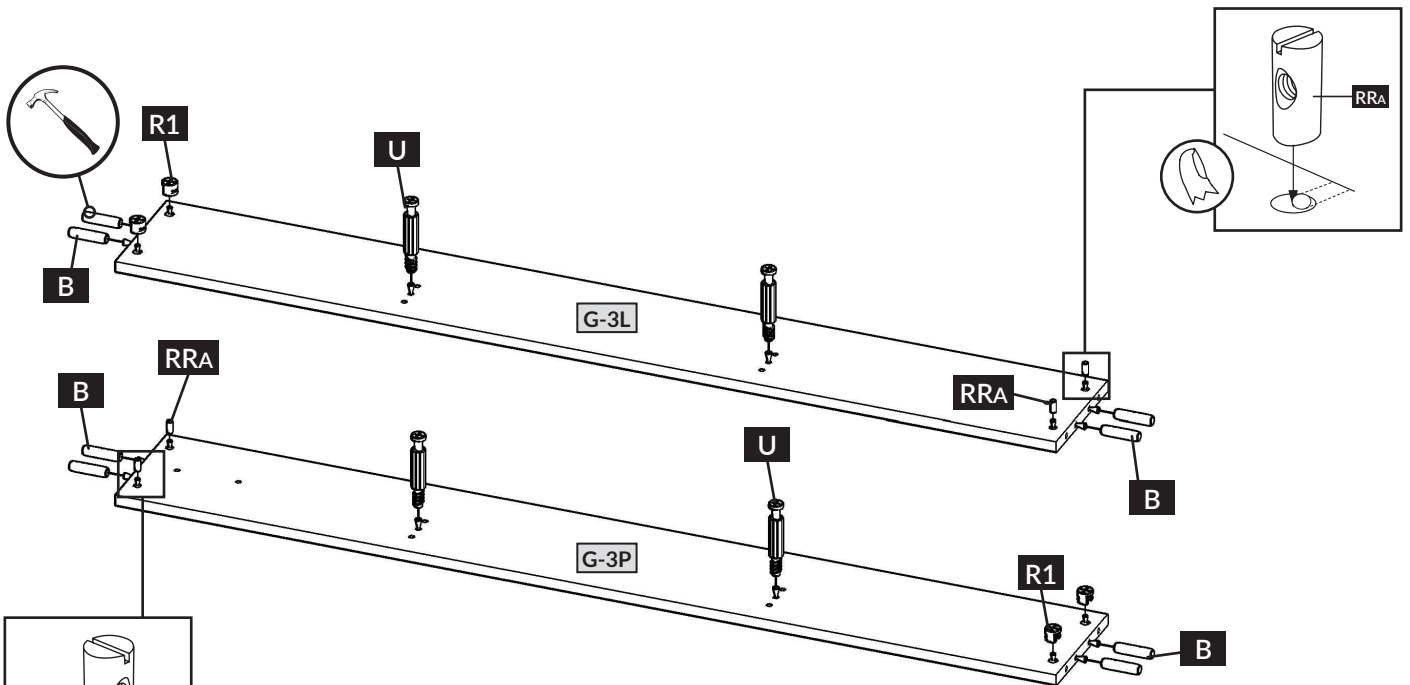
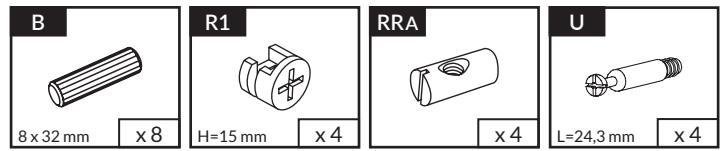

6

XELO - G

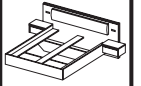

3

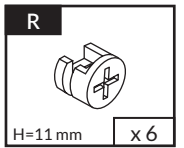

3x →

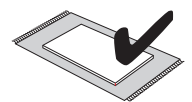
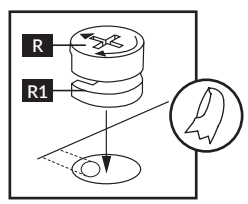
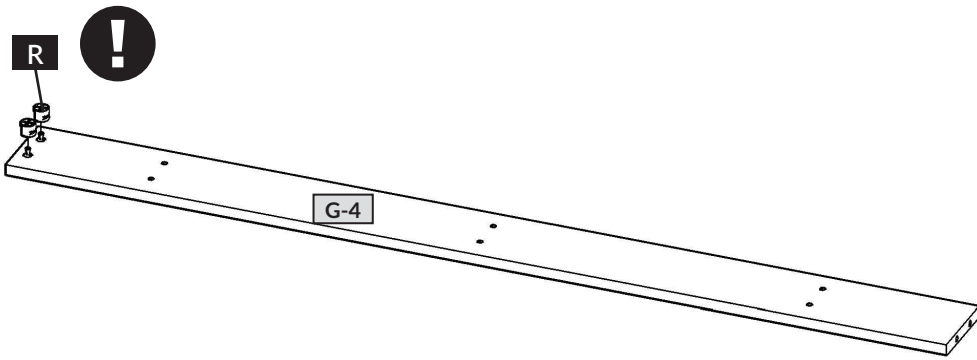

4

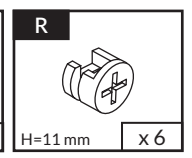
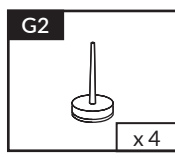
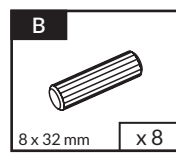

2x →

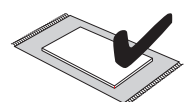
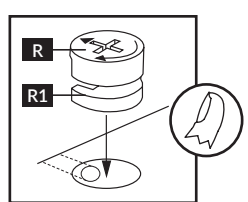
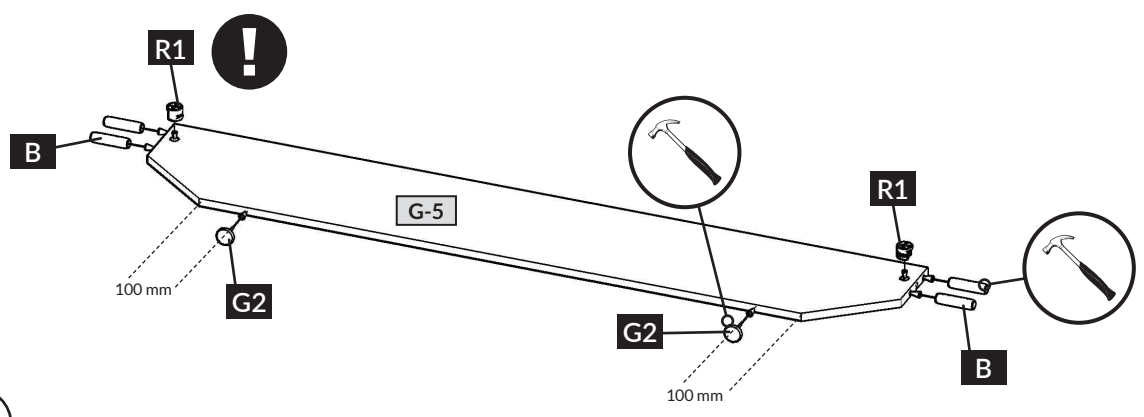

5

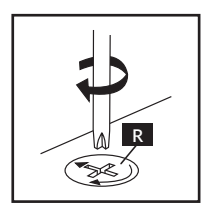
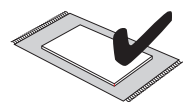
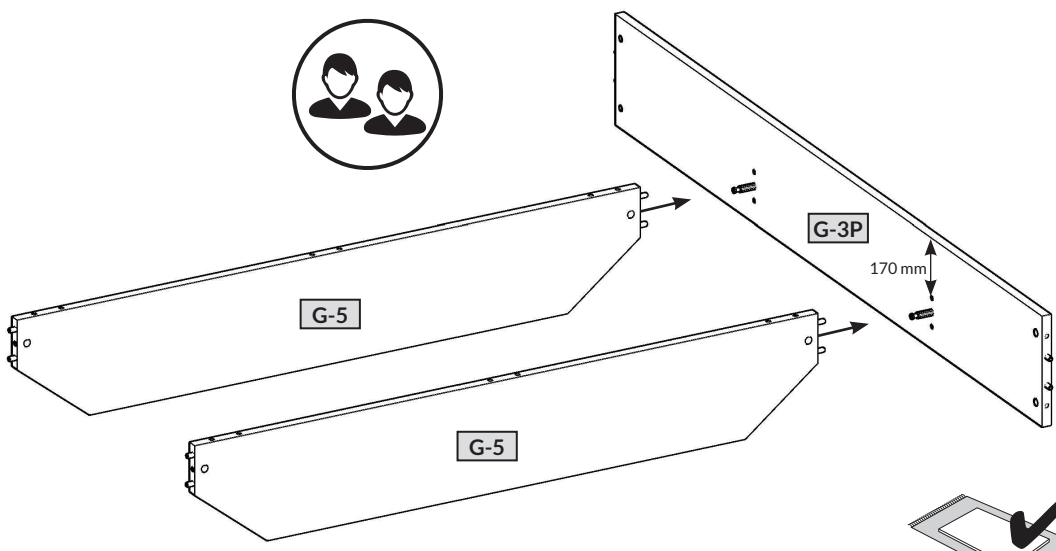

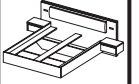

6

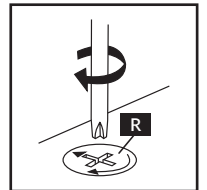
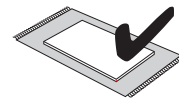
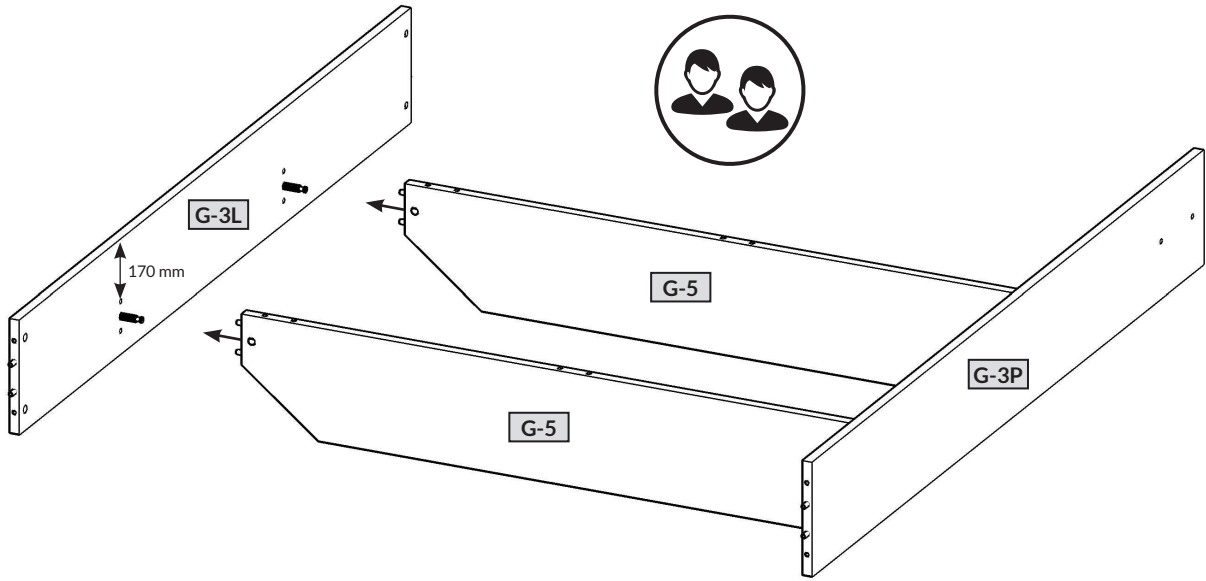

7

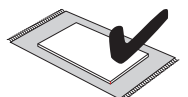
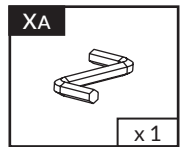
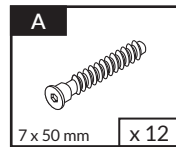
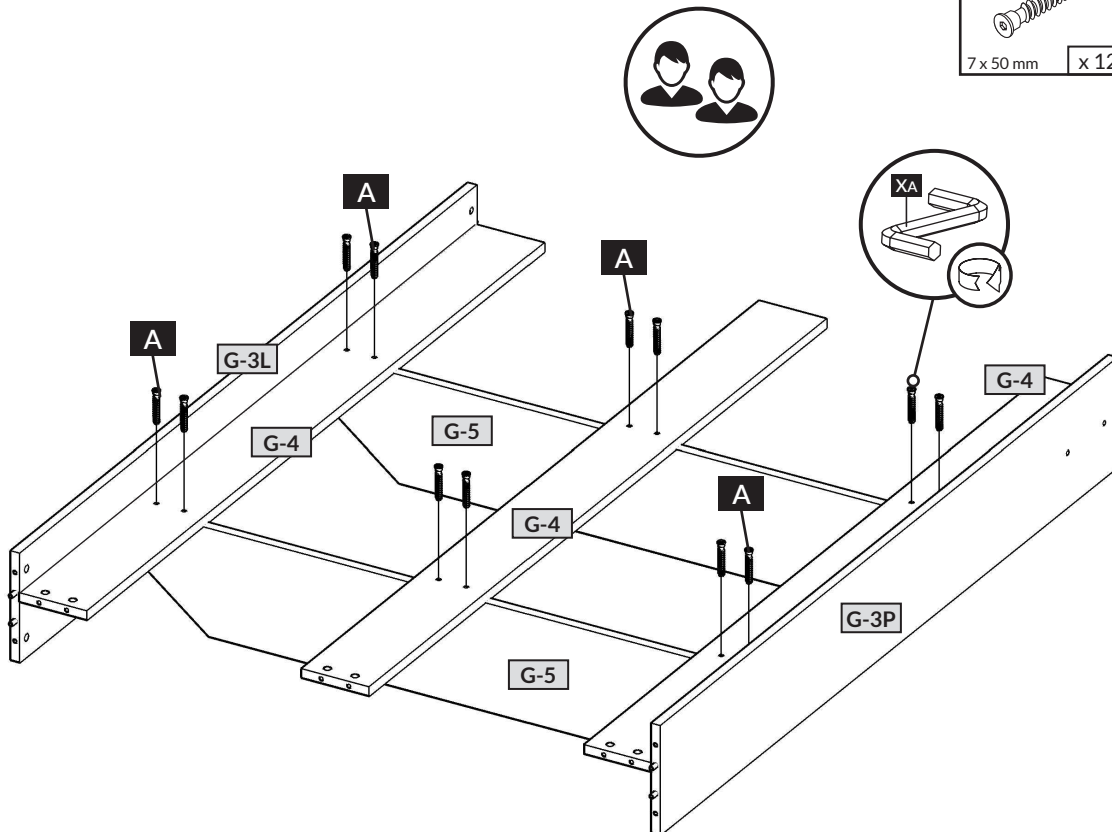

8

XELO - G

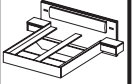

8

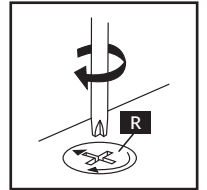
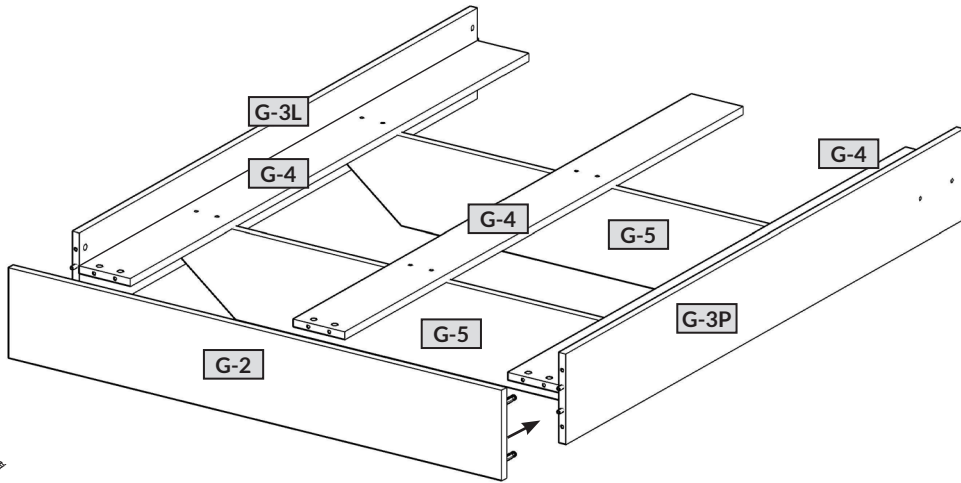

9

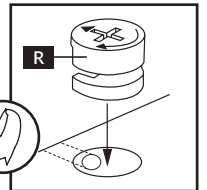
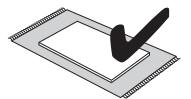
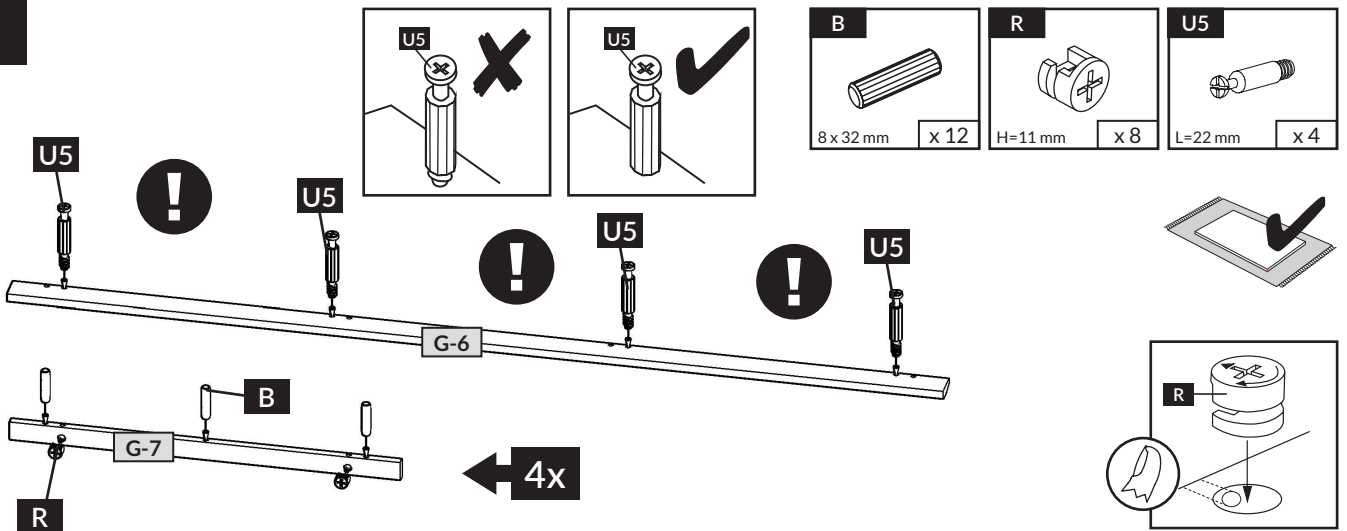

10

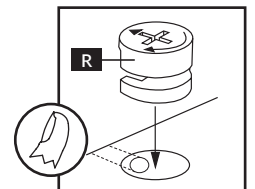
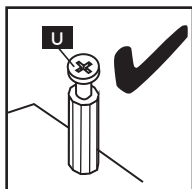
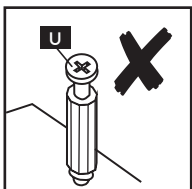
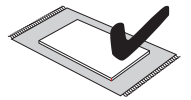
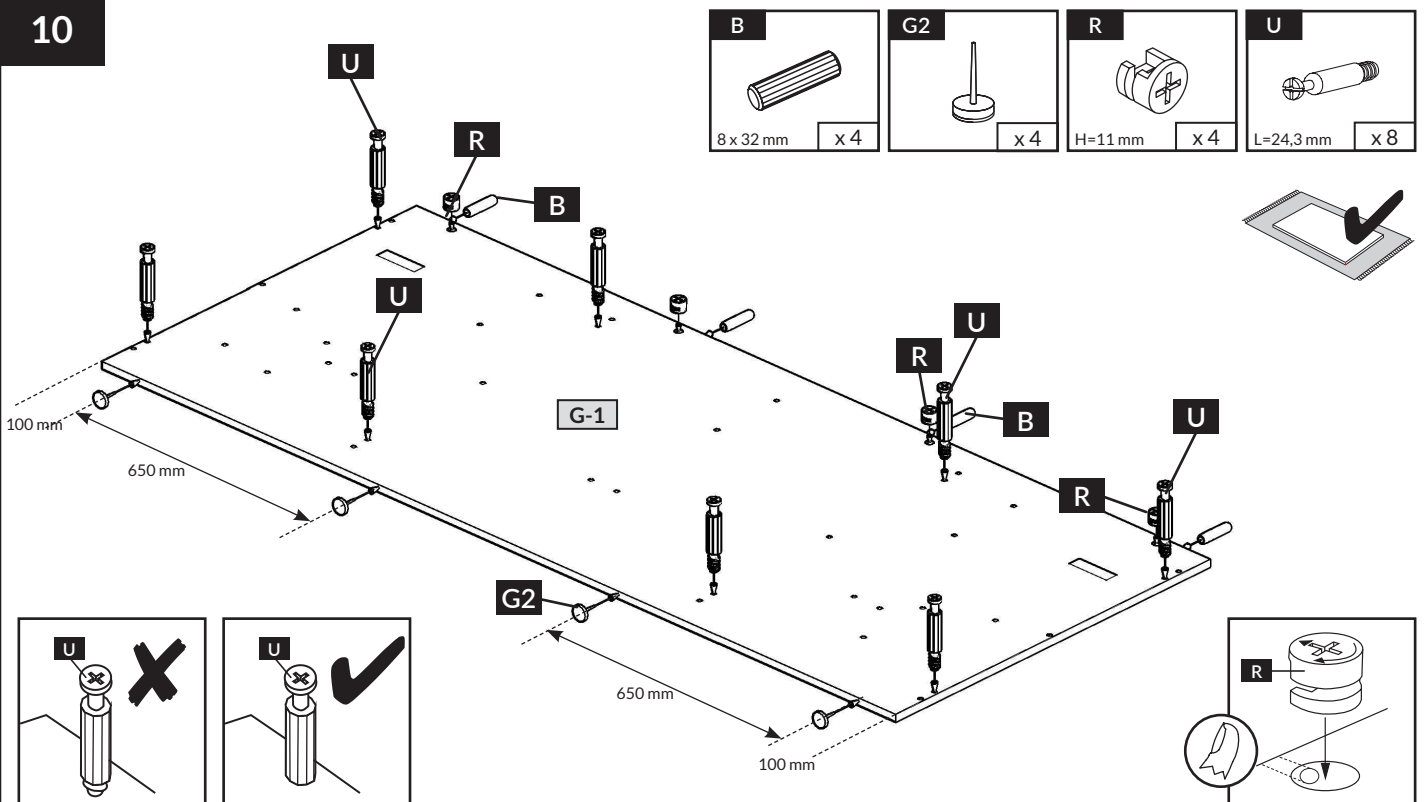



11

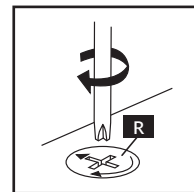
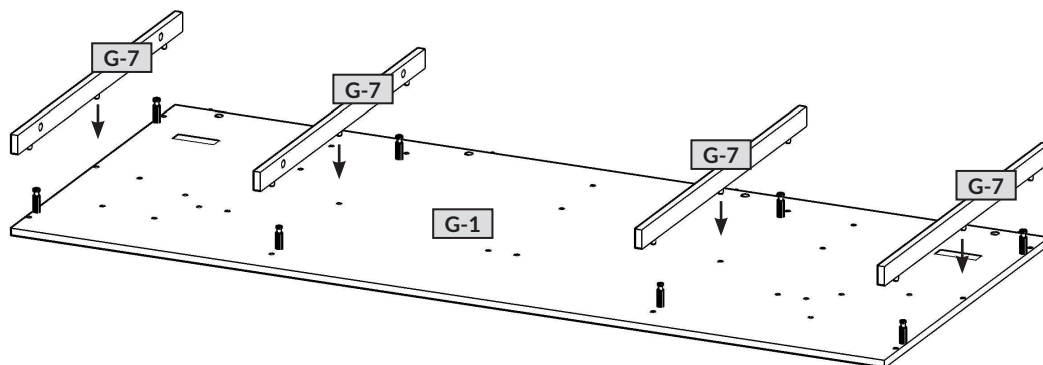

12

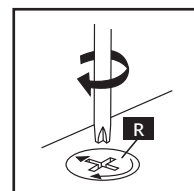
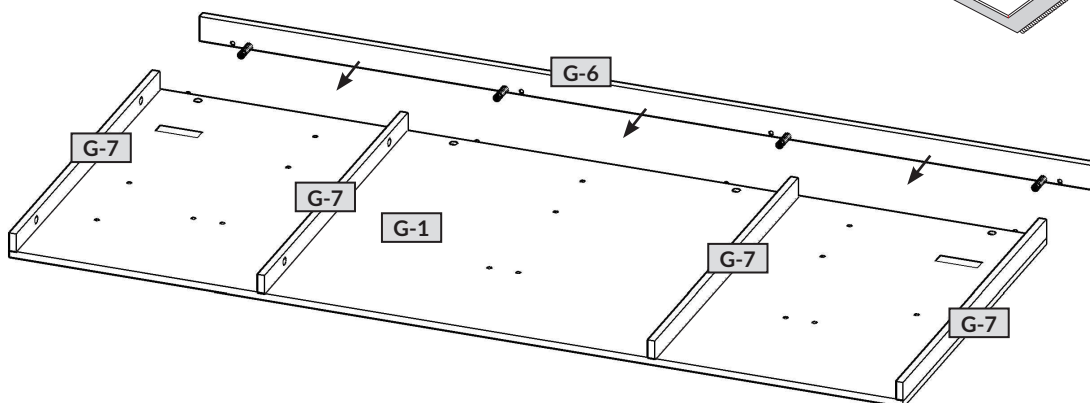

13

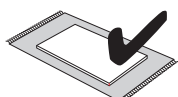
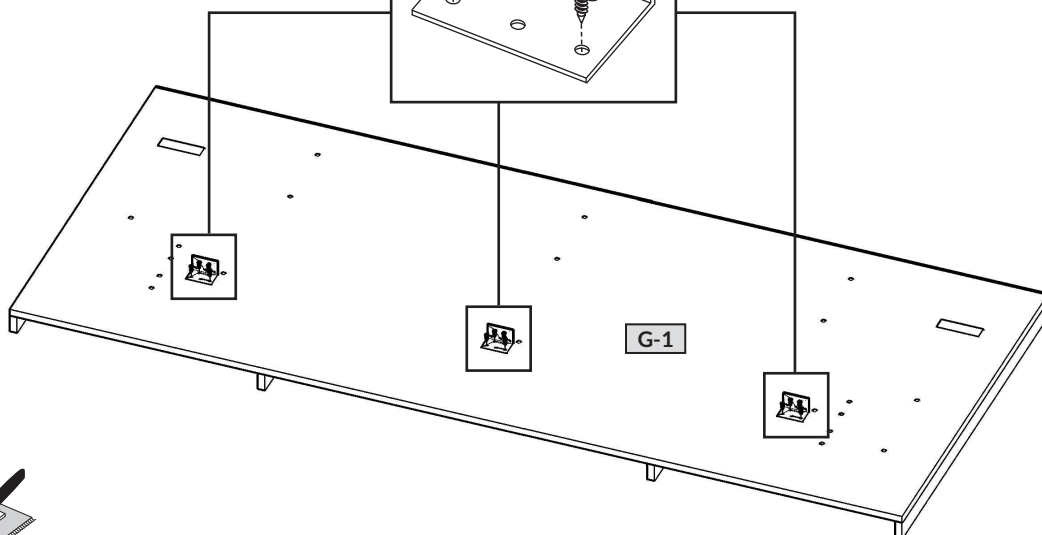
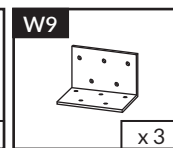
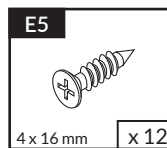
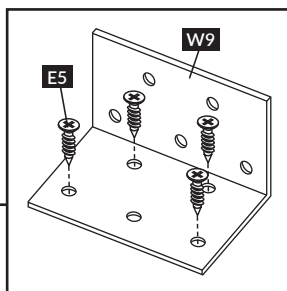

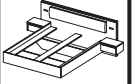

14

A 7 x 50 mm	RRB 6 x 55	XA x 1
x 6	x 4	x 1

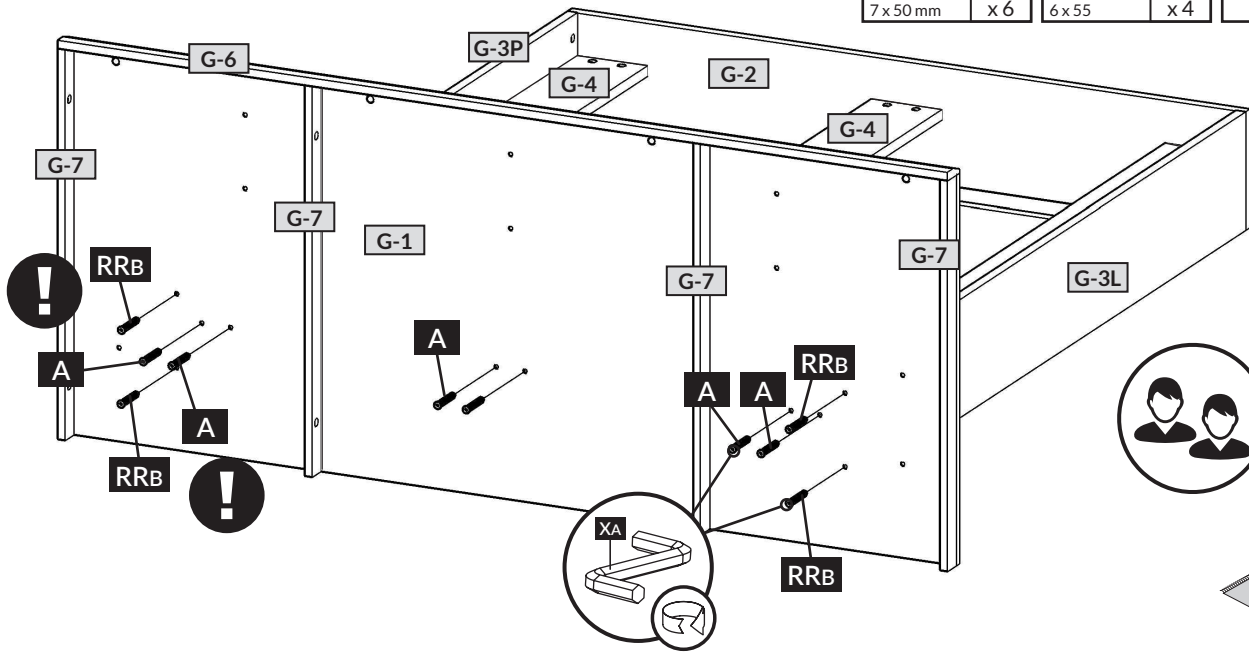

15

E5 4 x 16 mm
x 12

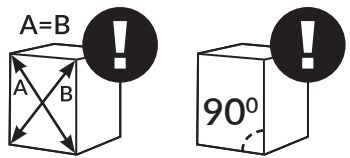
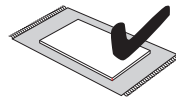
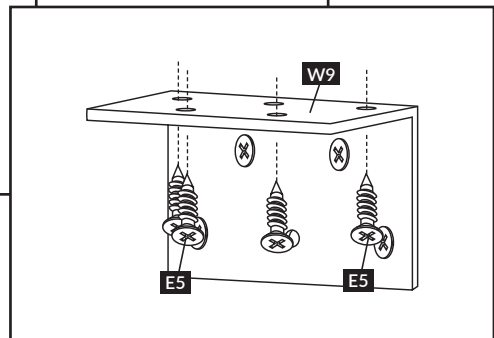
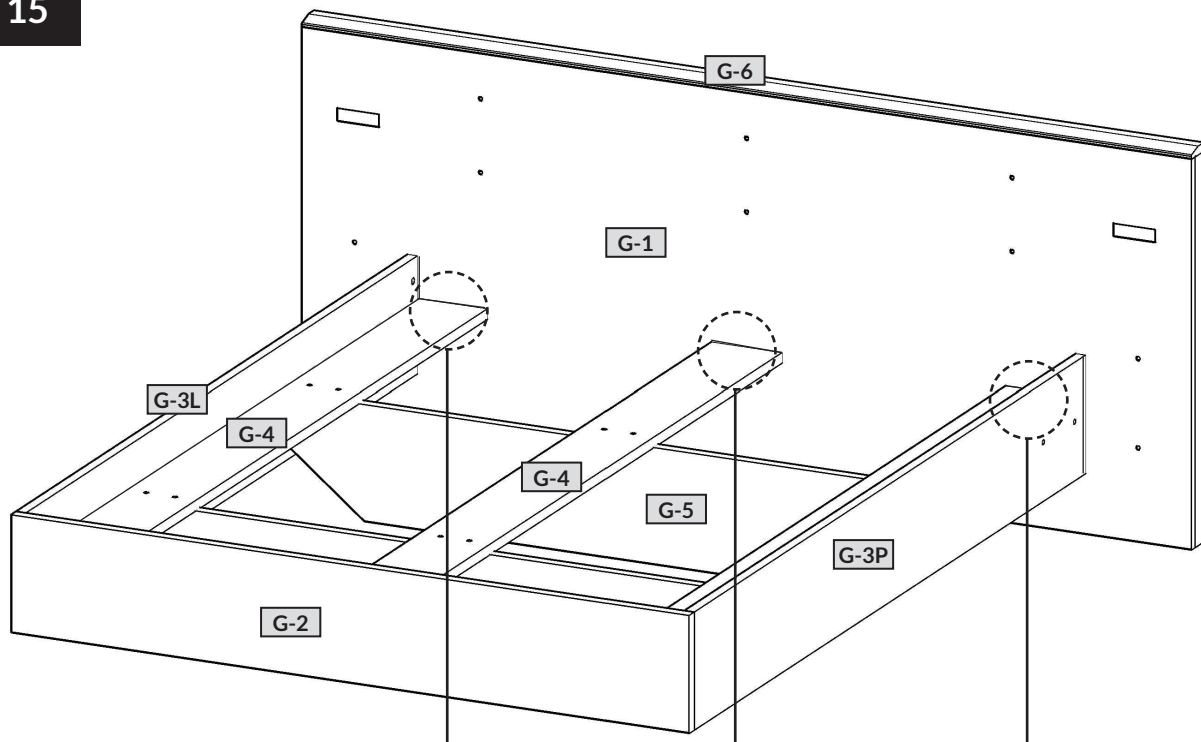

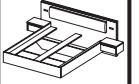

16

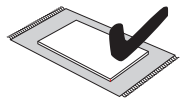
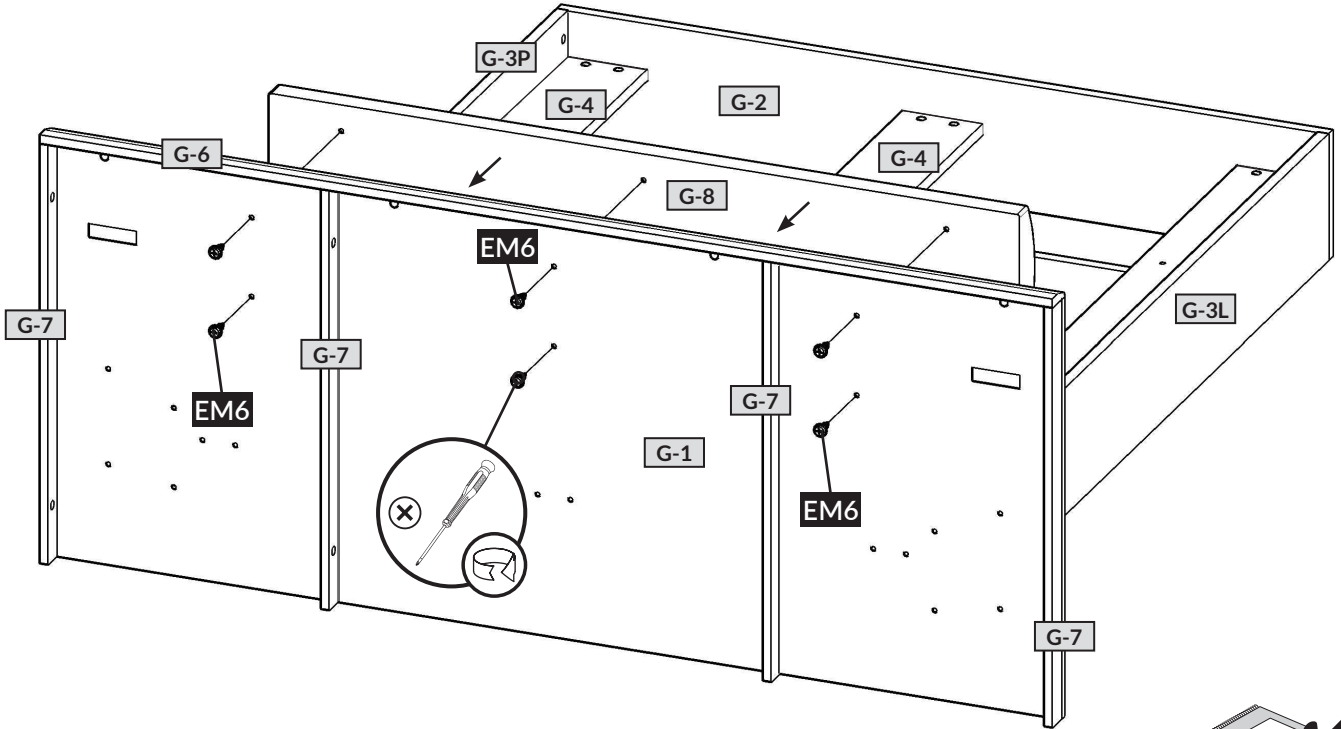
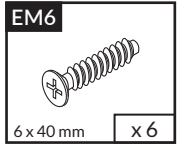

17

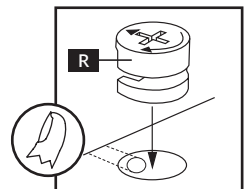
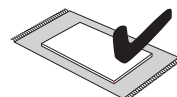
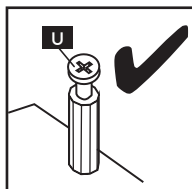
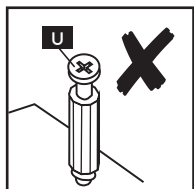
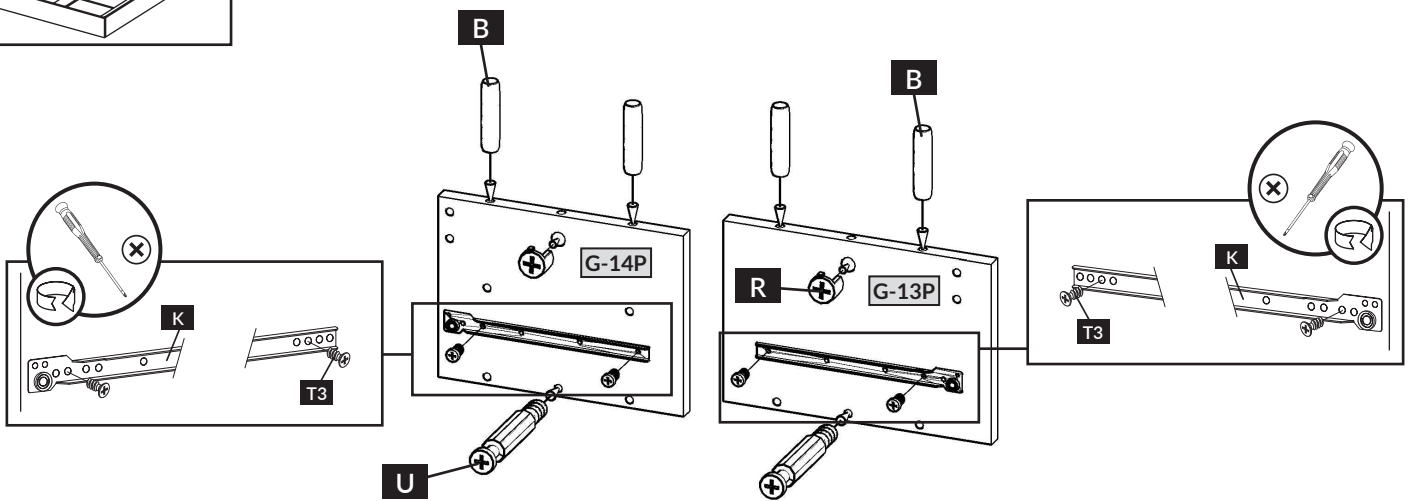
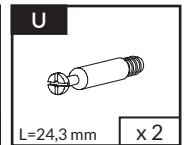
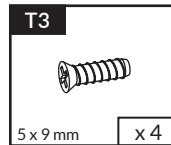
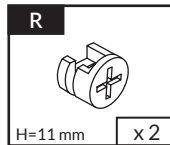
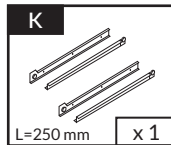
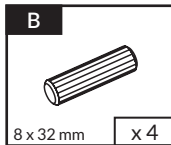
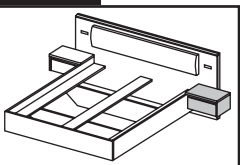

12

XELO - G

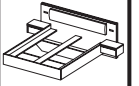

18

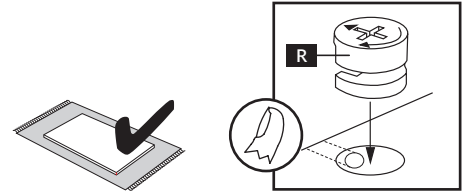
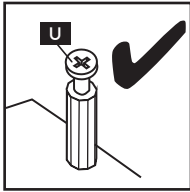
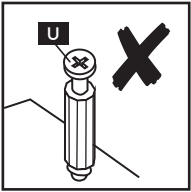
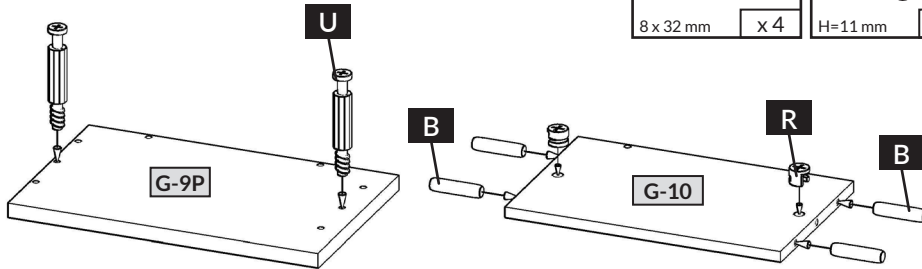
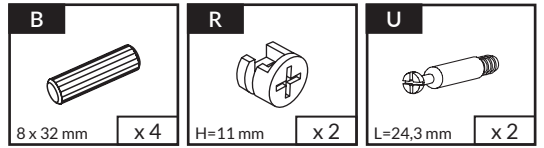

19

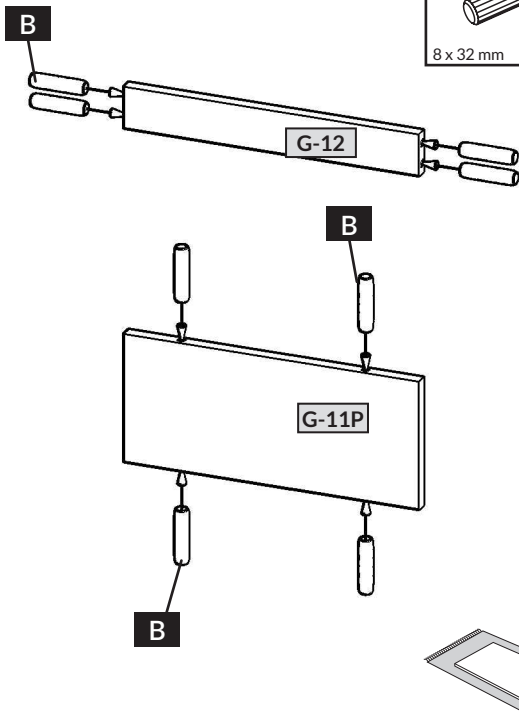
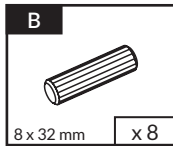

20

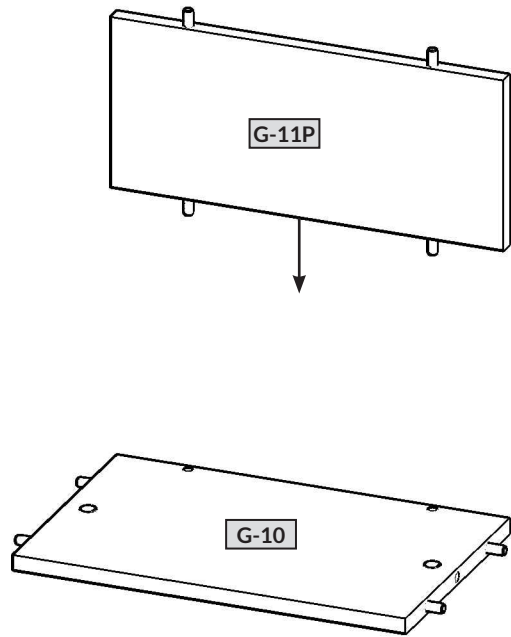
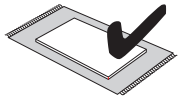

21

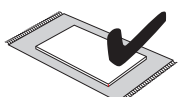
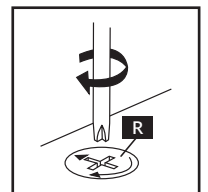
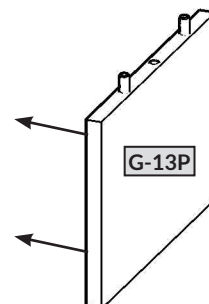
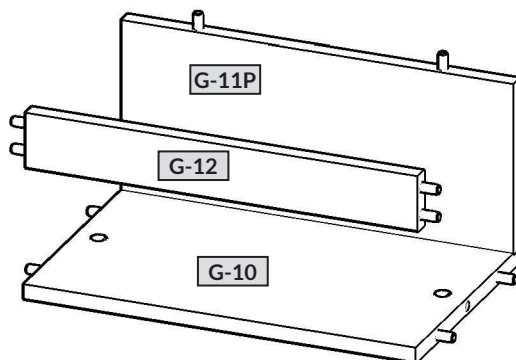

13

XELO - G

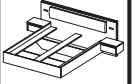

22

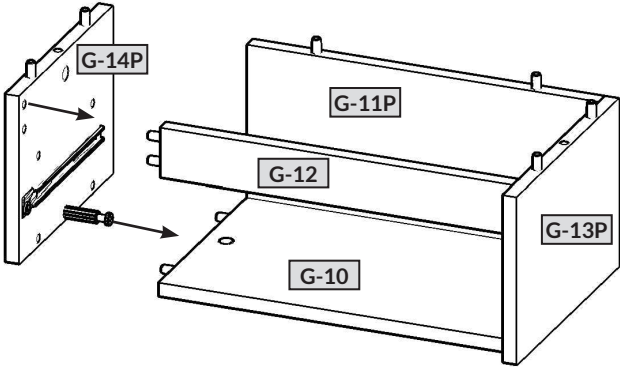
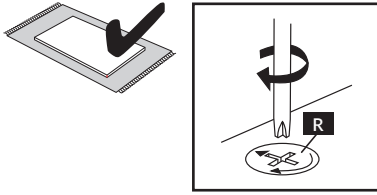

23

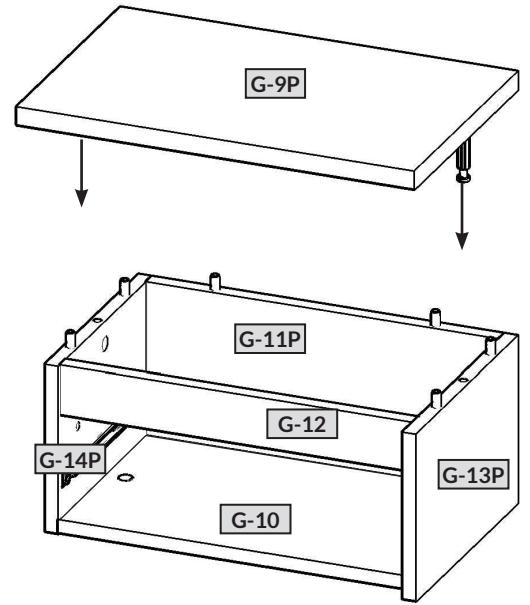
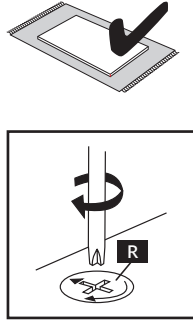

24

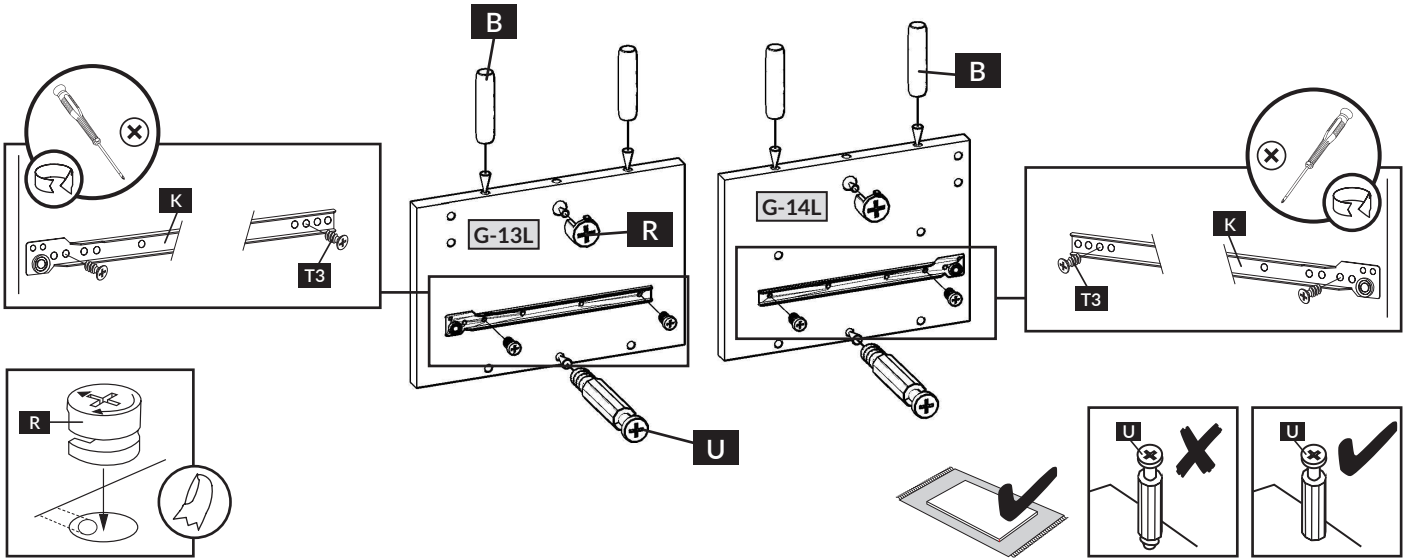
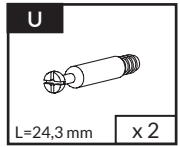
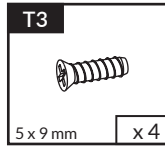
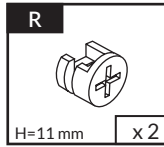
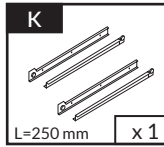
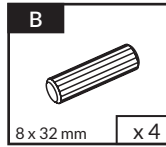
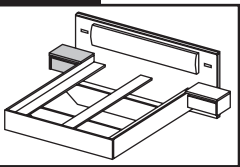

25

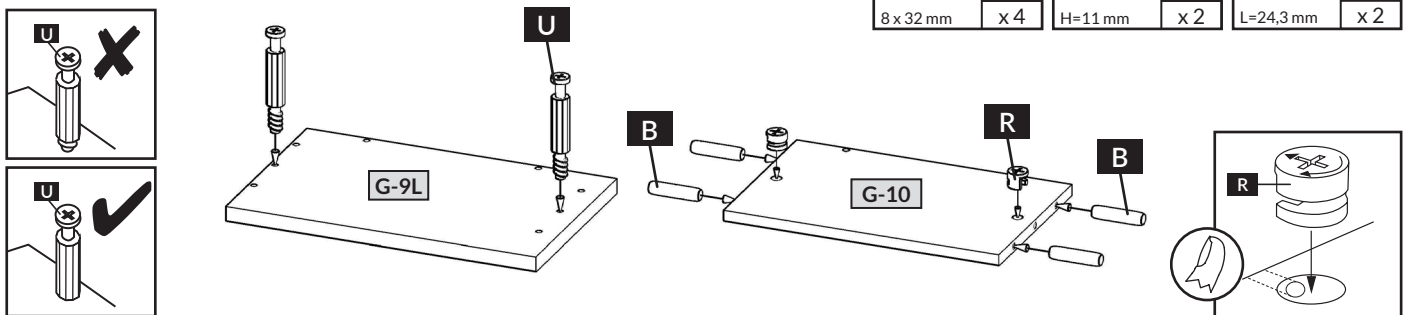
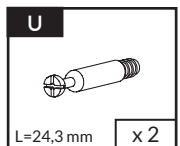
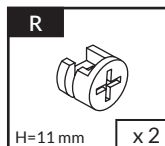
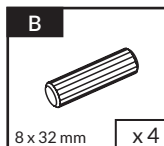
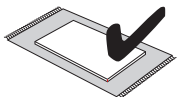

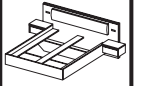

26

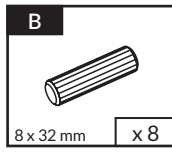
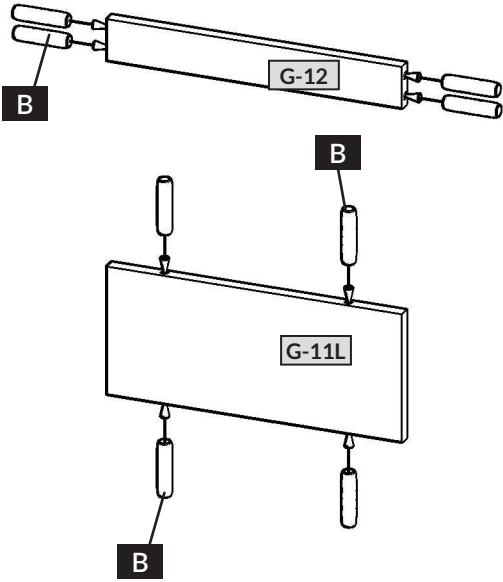

27

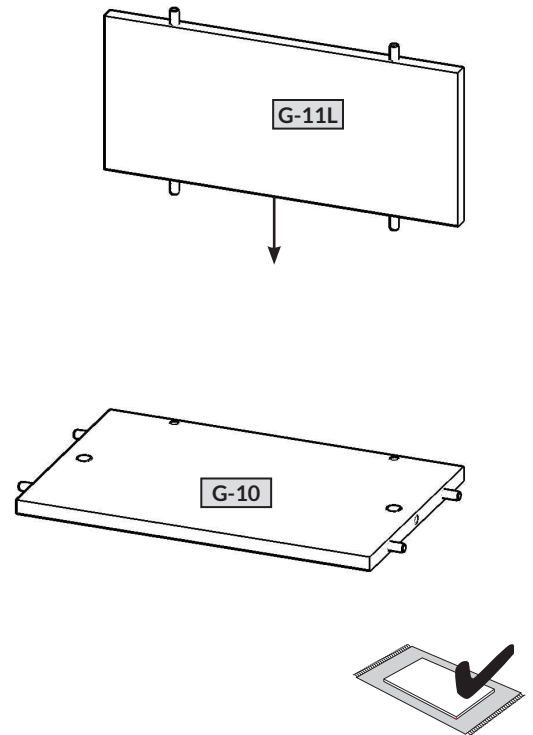

28

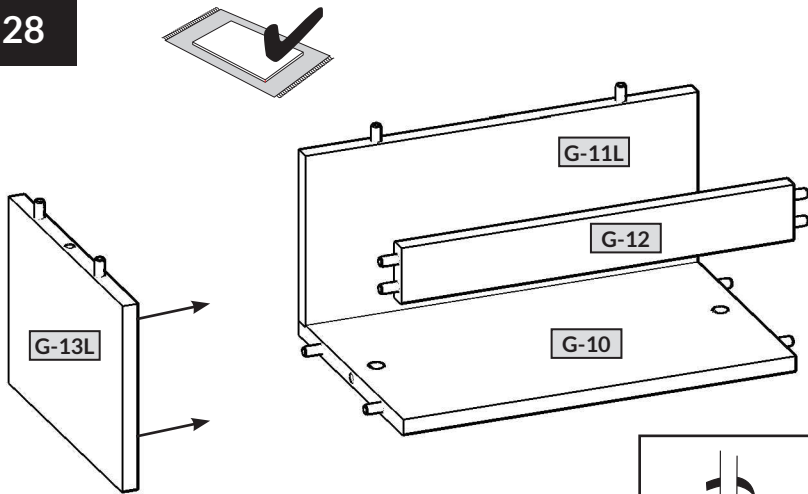

30

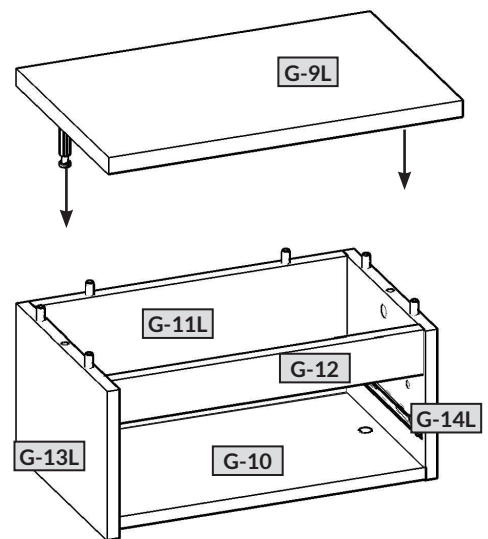
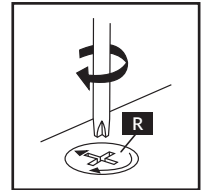

29

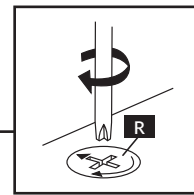
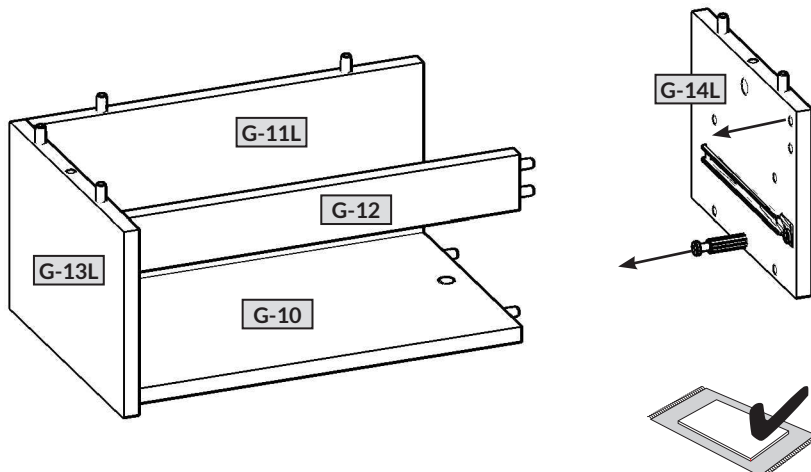

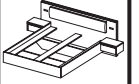

31

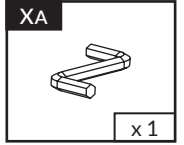
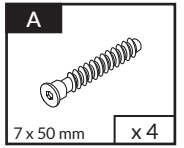
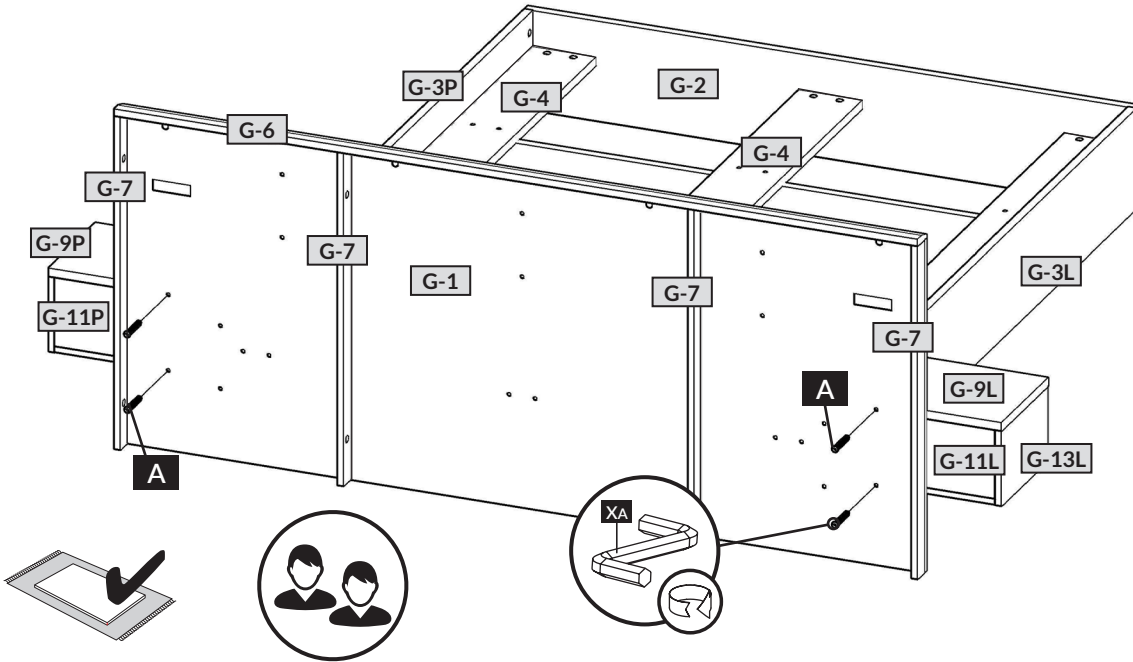

32

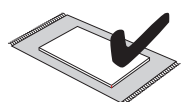
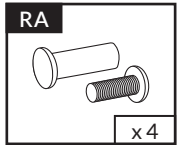
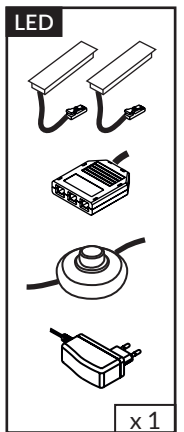
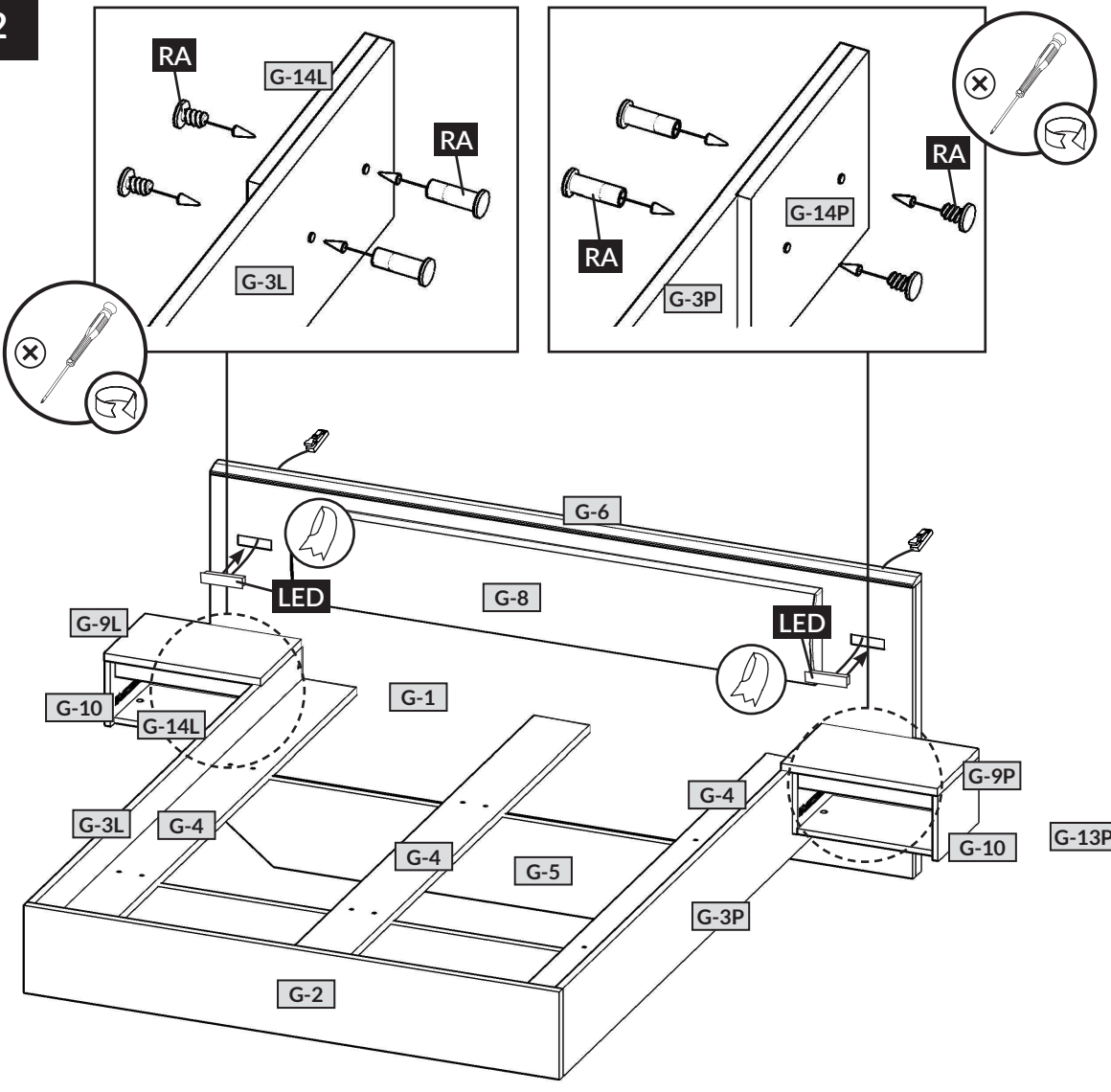

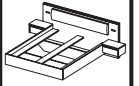

33

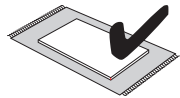
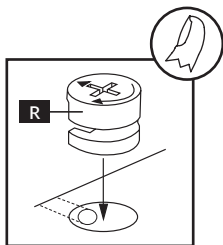
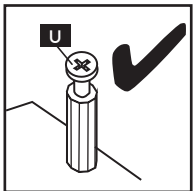
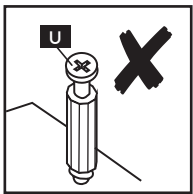
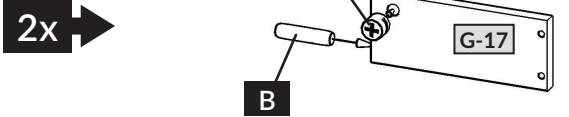
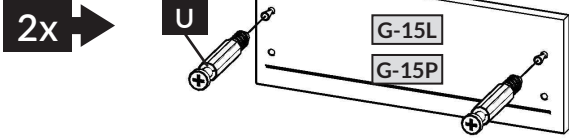
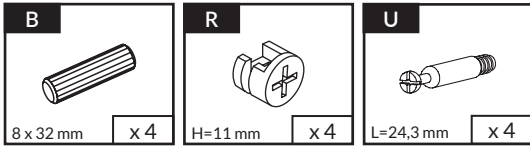

34

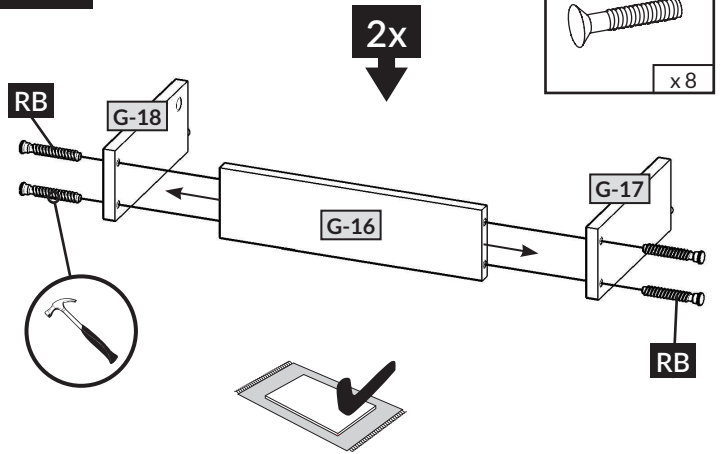
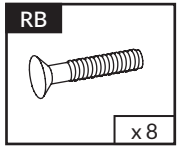

35

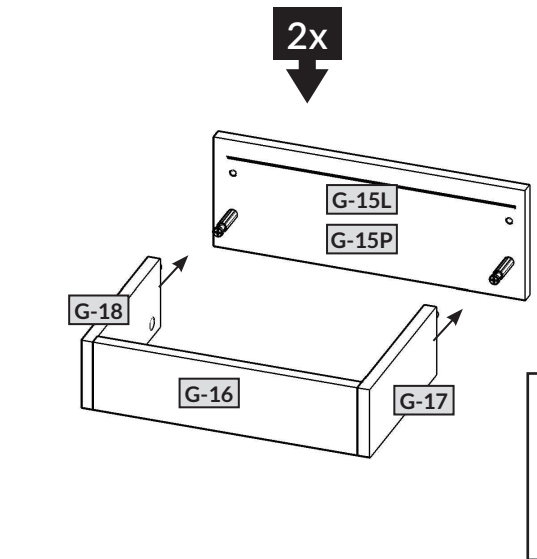
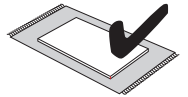

36

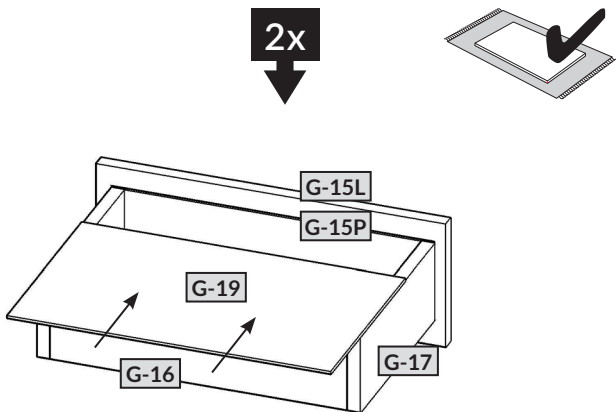

37

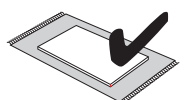
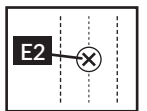
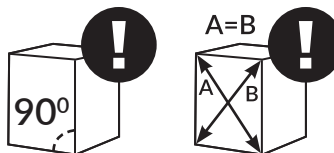
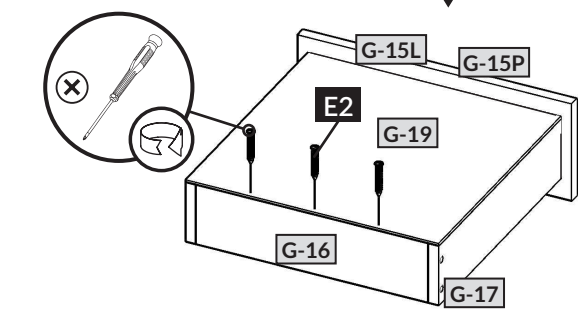
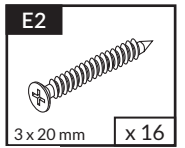

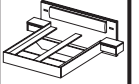

38

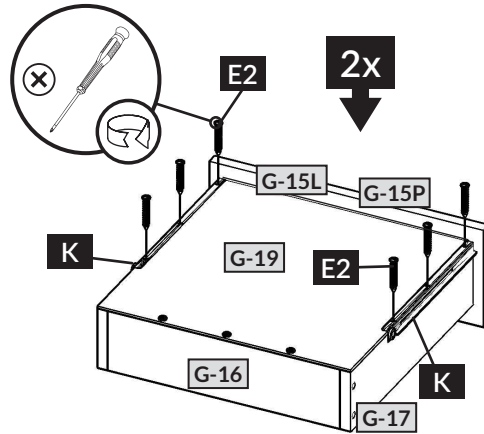
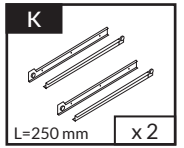
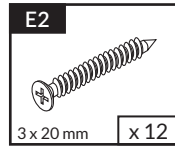

2x

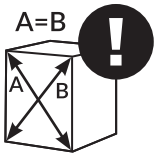
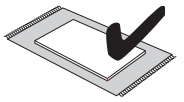
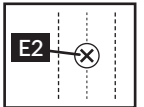

39

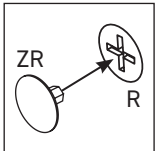
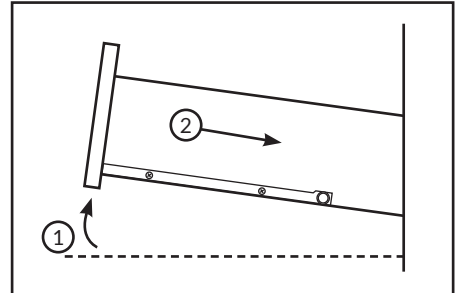
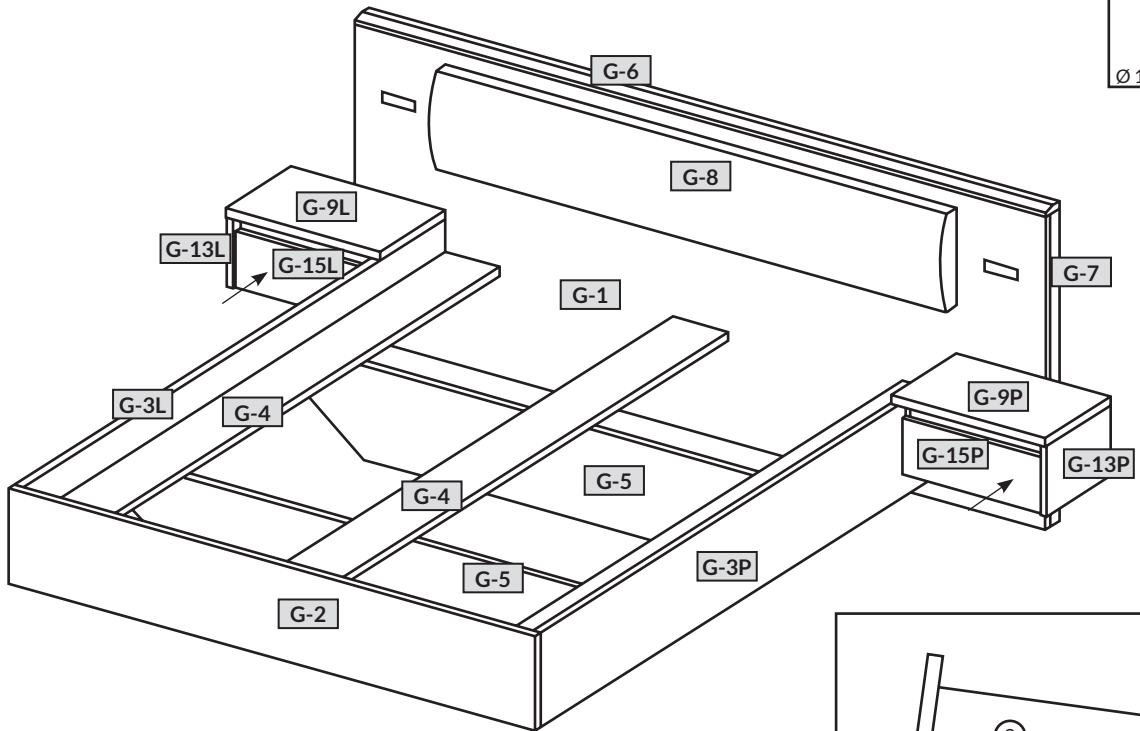
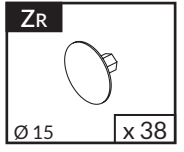

Name • Nom • Nome • Naam • Nazwa • Иméно
• Názov • Név • Denumire • Isim • Извание

Nr • No • N° • Номер • Č • Sz

Typ • Type • Tip • Típus • Tipo • Tun

XELO

G

D

Unser Direktservice für Beschlagteile
Sollte Ihnen ein Beschlagteil fehlen, können Sie diese Servicekarte
direct an die untenstehende Nummer senden. Wir können allerdings
nur Beschlagteile auf diesem Weg verschicken. Sollen Sie eine andere
Beanstandung an Ihrem Möbelstück haben, so wenden Sie sich bitte
direkt an Ihr Möbelhaus.

GB

Our direct order service for fitting
If a fitting should be missing to you, you know this service map
directly following number boxes. We can in this way send away
however only fitting. If you should have another objection to your
piece of furniture, then they turn please to your furniture house.

CZ

Naše přímé služby pro kování
Chybí-li vám nějaký díl z kování, můžete tuto servisní kartu odfaxovat
přímo na níže uvedené číslo. Touto cestou však můžeme zoslat jen
díly kování. Pokud byste reklamovali jiný díl nábytku, obraťte se přímo
na svého prodejce nábytku.

F

Bien étudier la notice de montage
Repérez les pièces constituant votre meuble. Regroupez et contrôlez la
quincaillerie. Munissez - vous de l'outillage nécessaire. Aménagez -
vous une zone de montage. Procédez au montage. Ne jamais forcer
les assemblages. Resserrez les vis après quelques temps d'usage.
Gardez votre notice de montage, si une pièce venait à manquer, elle
serait le plus clair moyen de communiquer avec votre magasin.

I

Il nostro servizio diretto per l'ordine della ferramenta
Nel caso vi mancassero dei pezzi, potete spedire fax questa carta di
servizi direttamente al seguente numero. Per altri reclami al vostro
mobile, potete rivolgervi al vostro mobilificio.

BG

Директно обслужаване на електрични делци "Обзор"
Ако ви недостига некои од делцима молимо вас да на дојде
наведениот број позивате овај сервисен образац. На овај начин могу
се доставити само делци. У случају да имате додатне приговоре везани
уз комода најмногу молимо вас да се обратите изравно трговини
најмногу готје је исти купител.

NL

Onze directservice voor losse onderdelen
Wanneer er een onderdeel mist kunt u deze servicekaart direct aan
onderstaand faxnummer sturen. Wij kunnen alleen langs deze weg
onderdelen versturen. Mocht u een ander probleem aan uw meubel
hebben verzeken wij u contact op te nemen met uw meubeldealer.

PL

Nasz bezpośredni serwis części montażowych
Jeżeli brakuje części koniecznych do montażu, prosimy o przesłanie
nam tej karty serwisowej na niżej podany numer faxu. Możemy w ten
sposób przysłać państwu tylko brakujące części. W przypadku innych
objawów dotyczących mebla, prosimy o zgłoszenie ich do salonu
meblowego w którym został dokonany zakup.

HR

Servis za okove
U slučaju da nedostaje neki od dijelova molimo vas da na dođe
navedeni broj pozivate ovaj servisni obrazac. Na ovaj način mogu
se dostaviti samo okovi. U slučaju da imate dodatne prigovore vezane
uz komad namještaja molimo vas da se obratite izravno trgovini
namještaja gdje je isti kupljen.

HU

Direktszolgálatunk vasalatok esetén
Ha hiányzik egy vasalat, ezt a kártyát közvetlenül elfaxolhatja az alább
található faxszámra. Azonban csak vasalokat tudunk így küldeni.
Amennyiben másféle reklamációt áll fenn bútordarabjait illetően,
forduljon közvetlenül a bútornáruhoz.

SK

Naše priamy servis pre časťi kovania
Ak by Vám chýbala nejaká časť kovania, môžete poslať túto servisnú
kártyu poslať faxom priamo na nižšie uvedené číslo. Díly
kovania vieme poslať iba týmto spôsobom. Ak by ste mali inú
reklamáciu ohľadom Vášho nábytku, obraťte sa priamo na Vašu
predajnú nábytku.

SLO

Naše direktno služne storitve za okovje
Ce vam manjka kakšno okovje, lahko to servisno kartico pošljete po
faksu direktno na spodnjo številko. Po tej poti vam lahko pošljemo
samo okovje. Če želite reklamirati kakšen drug del pohištva, se obrnite
neposredno na vašo trgovino pohitva.

RO

Service-ul nostru direct pentru feronerie
In cazul in care va lipsesc o piesa de feronerie puteti sa trimitezi
direct acest card de service pe fax la numarul de mai jos. Noi nu
putem expedia piese de feronerie decat pe acest fel de cale. Dacă aveți o
altă reclamație referitoare la piese de mobilier, atunci vă rugăm să vă
adresați direct la magazinul dvs. de mobilă.

RUS

Наш прямой сервис для поставок фурнитуры
Если окажется, что Вам не хватает того или иного элемента
фурнитуры, Вы можете отправить сервисную карту по факсу
непосредственно на нижеприведенный номер. Однако, таким
образом мы можем пересылать лишь фурнитуру. Если же у Вас
возникнут иные претензии относительно приобретенной мебели,
пожалуйста, обращайтесь непосредственно в организацию,
осуществляющую продажу.

S

Vår direktservice för beslagdelar
Om du saknar en beslagdel kan du faxa detta servicekort direkt till
numret som anges ned. Tänk på att detta är den enda möjligheten att
skicka beslagdelar till dig. Om du vill reklamera din möbel av en
annan anledning måste du kontakta ditt möbelhus direkt.

ES

Nuestro servicio directo para accesorios
Si le falta algún accesorio, puede enviar esta tarjeta de servicio
directamente a la siguiente dirección. No obstante, por este método
solo podemos enviar accesorios. Si tiene alguna otra objeción sobre su
mueble, consulte directamente con su mueblería.

TR

Detaylı bir doğrudan servisimiz
Bir donatınız eksikse bu servis kartını doğrudan aşağıda bulunan
adrese doğrudan mail yazabilirsiniz. Sadece bu yönde donatıları
gönderebiliriz. Mobilyanızda başka şikayetleriniz varsa lütfen doğrudan
mobilya satıcınıza danışın.

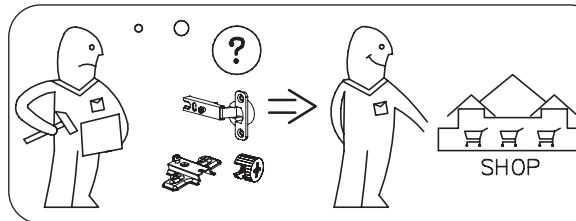
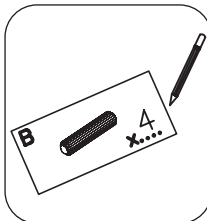
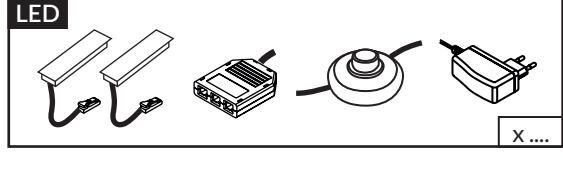
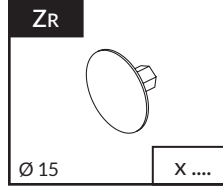
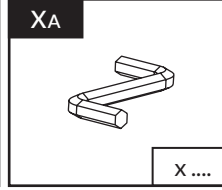
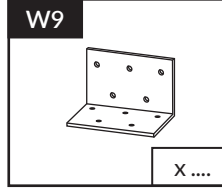
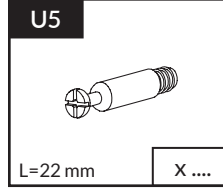
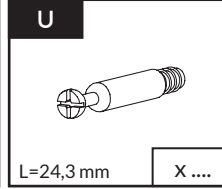
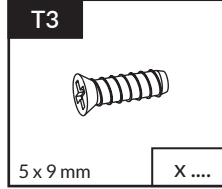
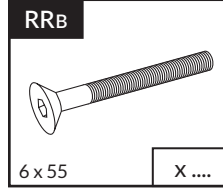
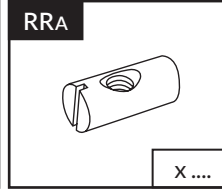
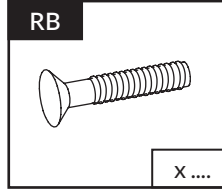
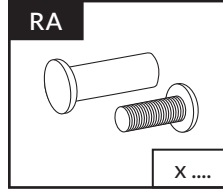
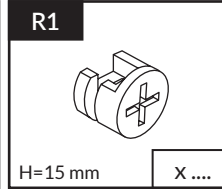
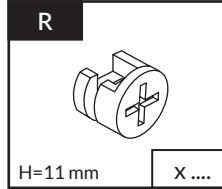
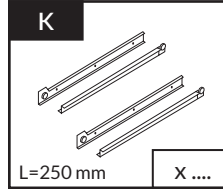
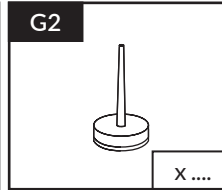
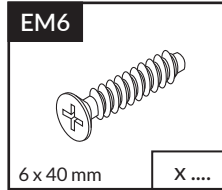
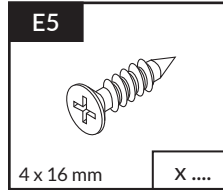
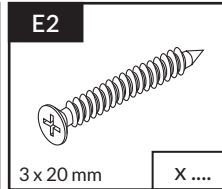
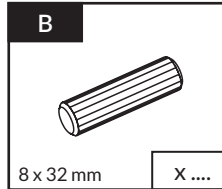
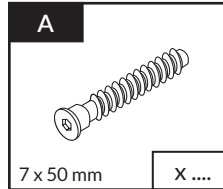

Name • Nom • Nome • Naam • Nazwa • Иméно • Názov • Néв • Denumire • Isim • Извание

XELO

Nr • No • N° • Номер • Č • Sz

Typ • Type • Tip • Típus • Tipo • Tun

G

D

Unser Direktservice für Beschlagteile
Sollte Ihnen ein Beschlagteil fehlen, können Sie diese Servicekarte direkt an die untenstehende Nummer senden. Wir können allerdings nur Beschlagteile auf diesem Weg verschicken. Sollen Sie eine andere Beanstandung an Ihrem Möbelstück haben, so wenden Sie sich bitte direkt an Ihr Möbelhaus.

GB

Our direct order service for fitting
If a fitting should be missing to you, you know this service map directly following number faxes. We can in this way send away however only fitting. If you should have another objection to your piece of furniture, then they turn please to your furniture house.

CZ

Naše přímé služby pro kování
Chybí-li vám nějaký díl z kování, můžete tuto servisní kartu odfaxovat přímo na níže uvedené číslo. Touto cestou však můžeme zoslat jen díly z kování. Pokud byste reklamovali jiný díl nábytku, obraťte se přímo na svého prodejce nábytku.

F

Bien étudier la notice de montage
Repérez les pièces constituant votre meuble. Regroupez et contrôlez la quincaillerie. Munissez - vous de l'outillage nécessaire. Aménagez - vous une zone de montage. Procédez au montage. Ne jamais forcer les assemblages. Resserrez les vis après quelques temps d'usage. Garder votre notice de montage, si une pièce venait à manquer, elle serait le plus clair moyen de communiquer avec votre magasin.

I

Il nostro servizio diretto per l'ordine della ferramenta
Nel caso vi mancassero dei pezzi, potete spedire fax questa carta di servizi direttamente al seguente numero. Per altri reclami al vostro mobile, potete rivolgervi al vostro mobilificio.

BG

Директно обслужаване на електрични делци "Обзор"
Ако ви недостига некои од делцата, можете директно да испратите овај сервисен образац на бројот на факс додека не дојде до потребните делци. Ако имате друга забелешка за вашето мебелско дело, молиме директно да се обратите на вашиот трговец со мебел.

NL

Onze directservice voor losse onderdelen
Wanneer er een onderdeel mist kunt u deze servicekaart direct aan onderstaand faxnummer sturen. Wij kunnen alleen langs deze weg onderdelen versturen. Mocht u een ander probleem aan uw meubel hebben verzoeken wij u contact op te nemen met uw meubeldealer.

PL

Nasz bezpośredni serwis części montażowych
Jeżeli brakuje części koniecznych do montażu, prosimy o przesłanie nam tej karty serwisowej na niżej podany numer faxu. Możemy w ten sposób przysłać państwu tylko brakujące części. W przypadku innych obiekacji dotyczących mebla, prosimy o zgłoszenie ich do salonu meblowego w którym został dokonany zakup.

HR

Servis za okove
U slučaju da nedostaje neki od dijelova molimo vas da na dojde naveštiti Fax broj posaljete ovaj servisni obrazac. Na ovaj način mogu se dostaviti samo okovi. U slučaju da imate dodatne prigovore vezane uz komad namještaja molimo vas da se obratite izravno trgovini namještaja gdje je isti kupljen.

HU

Direktszoállításunk vasalatók esetén
Ha hiányzik egy vasalató, ezt a kártyát közvetlenül elfaxolhatja az alább található faxszámra. Azonban csakis vasalatókat tudunk így küldeni. Amennyiben másféle reklamáció áll fenn bútorárbaját illetően, forduljon közvetlenül a bútorházhoz.

SK

Naše priamy servis pre časťi kovania
Ak by Vám chýbala nejaká časť kovania, môžete poslať túto servisnú kartu poslať faxom priamo na nižšie uvedené faxové číslo. Diely kovania vieme poslať iba týmto spôsobom. Ak by ste mali inú reklamáciu ohľadom Vášho nábytku, obraťte sa priamo na Vašu predajnú nábytku.

SLO

Naše direktno služne storitve za okovje
Ce vam manjka kakšno okovje, lahko to servisno kartico pošljete po faxu direktno na spodnjo številko. Po tej poti vam lahko pošljemo samo okovje. Če želite reklamirati kakšen drug del pohištva, se obrnite neposredno na vašo trgovino pohištva.

RO

Service-ul nostru direct pentru feronerie
In cazul in care va lipseste o piesa de feronerie puteti sa trimitemi direct acest card de service pe fax la numarul de mai jos. Noi nu putem expedia piese de feronerie decat pe acest fel de cale. Decat aveți o altă reclamație referitoare la piese de mobilier, atunci vă rugăm să vă adresați direct la magazinul dvs. de mobilă.

RUS

Наш прямой сервис для поставок фурнитуры
Если окажется, что Вам не хватает того или иного элемента фурнитуры, Вы можете отправить сервисную карту по Факсу непосредственно на нижеприведенный номер. Однако, таким образом мы можем пересылать лишь фурнитуру. Если же у Вас возникнут иные претензии относительно приобретенной мебели, пожалуйста, обращайтесь непосредственно в организацию, осуществляющую продажу.

S

Vår direktservice för beslagdelar
Om du saknar en beslagdel kan du faxa detta servicekort direkt till numret som anges ned. Tänk på att detta är den enda möjligheten att skicka beslagdelar till dig. Om du vill reklamera din möbel av en annan anledning måste du kontakta ditt möbelhus direkt.

ES

Nuestro servicio directo para accesorios
Si le falta algún accesorio, puede enviar esta tarjeta de servicio directamente a la siguiente dirección. No obstante, por este método solo podemos enviar accesorios. Si tiene alguna otra objeción sobre su mueble, consulte directamente con su mueblería.

TR

Donatilar için doğrudan servisimiz
Bir donatınız eksikse bu servis kartını doğrudan aşağıda bulunan adrese doğrudan mail yazabilirsiniz. Sadece bu yolla donatılar gönderilebilir. Mobilyanızda başka şikayetleriniz varsa lütfen doğrudan mobilya satıcınıza danışın.

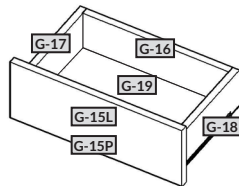
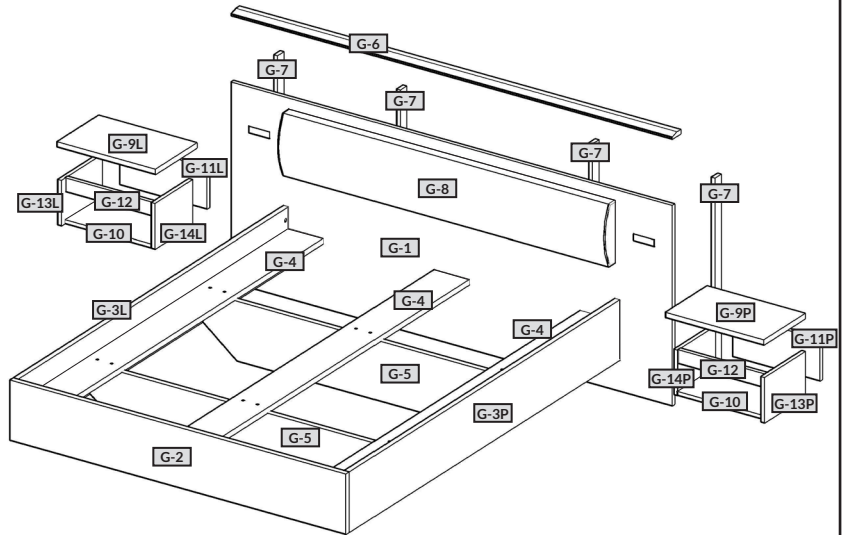

G-1	2158	900	16	x 1	1/2
G-2	1644	274	22	x 1	2/2
G-3L	2000	270	22	x 1	2/2
G-3P	2000	270	22	x 1	2/2
G-4	2000	170	16	x 3	2/2
G-5	1600	268	22	x 2	1/2
G-6	2158	60	18	x 1	1/2
G-7	900	44	16	x 4	2/2
G-8	1600	280	75	x 1	2/2
G-9L	480	305	22	x 1	1/2
G-9P	480	305	22	x 1	1/2
G-10	426	275	16	x 2	1/2
G-11L	426	186	16	x 1	1/2
G-11P	426	186	16	x 1	1/2
G-12	426	60	16	x 2	2/2
G-13L	300	203	16	x 1	2/2
G-13P	300	203	16	x 1	2/2
G-14L	275	203	16	x 1	2/2
G-14P	275	203	16	x 1	2/2
G-15L	438	162	16	x 1	1/2
G-15P	438	162	16	x 1	1/2
G-16	372	100	16	x 2	2/2
G-17	250	100	16	x 2	2/2
G-18	250	100	16	x 2	2/2
G-19	403	257	3	x 2	1/2

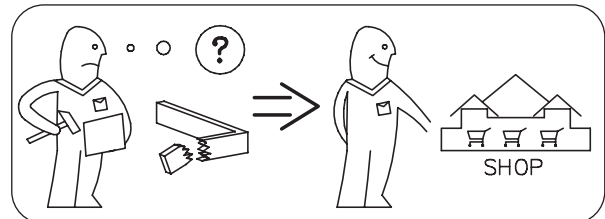

DE Möbel aus Naturholz und Plattenwerkstoffen

PL Mebel z drewna naturalnego oraz płyt drewnopochodnych

NL Meubelen van natuurhout en plaatmateriaal

GB Furniture made of natural wood and panel materials

IT Mobili in legno naturale e materiali pannellati

FR Meuble en bois naturel et plaque en dérivé du bois

PT Móveis feitos de madeira natural e tábuas semelhanhantes a madeira

DE
Liebe Kundin,
lieber Kunde,

Wir dank Ihnen Bestellung!
Gleichzeitig ob Sie ein aus Naturholz gefertigtes Möbelstück gekauft haben, eine Hochglanzfront oder eine matte Kunststofffront – jedes Möbelstück hat seine ganz speziellen Eigenschaften. Auch Holzbeschaffenheit und -struktur, Naturholzbeinle oder Astbe in der Naturholzbeinle, sind Teil der individuellen Bestimmung jedes einzelnen Möbelstückes.

Da Möbel aus Naturholz ständigen Klima- und Feuchtigkeitsschwankungen ausgesetzt sind, können vereinzelt Veränderungen in der Oberfläche auftreten wie z.B. Haarrisse oder Farbveränderungen. Generell nimmt im Laufe der Zeit die Helligkeit ab und die Farbsättigung zu – das Holz dunkelt nach.

Die im Natur-Rohstoff wie Holz ein normaler Prozess.

Dieses Büchlein soll Ihnen ein paar Tipps zur Pflege Ihres Möbelstücks geben, damit Sie lange Freude daran haben können.

Grundätzlich gilt:

- Meiden Sie heißen Gegenstände auf die Möbeloberfläche.
- Keine Kerzen direkt auf die Möbel stellen.
- Verschlutete Flüssigkeiten sofort aufwischen.
- In regelmäßigen Abständen einen festen Sitz von Schrauben und Beschlägen kontrollieren.
- Der typische, aromatische Holzgeruch des Naturholzmöbels immer ein Zeichen für Qualität.
- Heiße Stellen an den Händen entstehen durch einen natürlichen Hautausstritt und können mit einem trockenen, fusselfreien Tuch abpoliert werden.
- Auch von anderen Holz-, Lack-, Leder- oder Polstermaterialien ist ein schwacher Eigengeruch am Anfang unvermeidbar. Diese Gerüche verschwinden mit der Zeit von allein.
 - Was Sie dem möbel helfen wollen, Lüften Sie in der Anfangszeit häufiger und/oder wischen Sie die Möbel leicht feucht mit Wasser aus, das mit ein wenig Essig versetzt ist.
 - Bewahren Sie diese Hinweise gut auf.

Pflegehinweise für Möbel aus Plattenwerkstoffen

Verwenden Sie zur Pflege Ihres Möbels aus Plattenwerkstoffen am besten ein weiches, sauberes, nicht abstrahlendes Lintuch. Wischen Sie die Oberflächen leicht feucht ab.

Grundätzlich gilt:

- Verwenden Sie bitte auf keinen Fall lösende Reinigungs- und Putzmittel.
- Microfasertücher oder **Schmutzradierer**. Diese enthalten häufig feine Schmelzpartikel, die zu einem Zerknäten des Möbels führen können.
- **Scharfe chemische Substanzen** sowie **scheuernde Putz- oder Lösungsmittel**. Diese können die Oberflächen ebenfalls beschädigen;
- **Scheuerpapier, Stahlwolle** oder **Poliermittel**. Sie zerstören die Oberfläche so stark, dass eine Aufarbeitung nicht mehr möglich ist;
- **Staubsauger** und **Bürsten** können die Oberflächen durch ihren Druck und die Hitze, mit denen der Wasserdampf auf die Oberflächen trifft, können diese beschädigt werden oder sich sogar vom Untergrund ablösen.

TR Doğal ahşap ve kereste malzemelerden Üretilmiş mobilyalar

RU Мебель из натурального дерева и древесных панелей.

RO Mobilii din lemn natural și materiale fibrolemnoase

CZ Nábytek z přírodního dřeva a deskových materiálů

SK Nábytok z prírodného dreva a drevovláknitých deskových materiálov

HU Bűtor természetes faanyagból és bútortápból

ES Muebles de madera natural y tableros símil madera

NL
Beste klant,

Hierbij dank voor uw bestelling!
Het maakt niet uit of u een meubelstuk koopt met een hoogglanzende voorkant of een mat plastic voorkant heel gekoekt – elk meubelstuk heeft zijn heel bijzondere eigenschappen. Ook de staat en structuur van het hout zoals kleinere takken bij natuurhout meubelen maken deel uit van de individuele look van elk afzonderlijk meubelstuk.

Omdat meubelen van natuurhout zijn vervaardigd, zijn permanente klimaatveranderingen en vochtigheidsveranderingen er af en toe bijzigtig op de afwerking van de bovenlaag zoals haarscheutjes of kleurveranderingen. In het algemeen neemt na verloop van tijd de helderheid af en de kleurverzadiging toe – het hout wordt donkerder.

De genoemde wijzigingen vormen bij een natuurlijke grondstof zoals hout een normaal proces.

Dit boekje moet u een paar tips geven om uw meubelstuk van uw bestuk, zodat u er lange tijd plezier aan kunt beleven.

In principe geldt:

- Plaats geen hete voorwerpen op de meubelen.
- Plaats geen kaarsen direct op de meubelen.
- Veeg gemorstte vloeistoffen direct af.
- Controleer met regelmatige intervalen de beslag- en houtvast van schroeven en bouten.
- De typische, aromatische houtgeur is steeds een kwaliteitsbewijs bij natuurhout meubelen.
- Heldere plaatsen aan de takken ontstaan door een natuurlijk uitdrennen van hars en kunnen worden weggepoijst met een droge, pluisjevrije doek.
- Ook van andere houten, gelakte, lederen of polsterde materialen is er een zwakke eigen reuk bij het begin niet te vermijden. Deze geuren verdwijnen op hunzelf vanzelf.
 - Als u wilt dat het sneller gaat, verlucht u in het begin vaker en/of veegt de meubelen lichtjes vochtig af met water, dat een beetje is aangelengd met azijn.
 - Bewaar deze instructies goed.

Onderbouwstructuurs voor meubelen

Gebruik voor de reiniging van uw meubel van plaatmateriaal het best een zachte, niet pluiszige doek of een leren doek. Veeg de oppervlakten leraf vochtig af.

In principe geldt:

- Gebruik **zeker niet** volgende reinigings- en poetsmiddelen:
 - **microvezelstoffen** of **voetmiddelen**. Deze bevatten vaak fijne spindelvezels die de lak erden tot waszen op de oppervlakten.
 - **scherpe chemische substanties** zoals **oplosmiddelen**.

Deze kunnen de oppervlakken eveneens beschadigen;

- **schuurpapier, staalwol of pampensponzen**. Ze vernietten het oppervlak zo erg dat een reparatie niet meer mogelijk is;
- **stofzuiger**. Mondstukken en borstels kunnen beschadigen op de oppervlakten;
- **stoomreiniger**. Door de hoge druk en de hitte, waarmee de stoom op de bovenlagen komt, kunnen deze worden beschadigd of zelfs loskomen van de ondergrond.

GB Dear customer,

Thank you for your order!
No matter if you bought a piece of furniture made from natural wood, a high-gloss front or a plastic front – every piece of furniture has unique characteristics. Even the texture and structure of wood, such as small knots in natural wood furniture, are part of the individual charisma of each piece of furniture. Since natural wood furniture are permanently exposed to climate and humidity fluctuations, changes to the surface may occur (e.g. hair cracks or changes in colour) in some cases. In general, brightness decreases and colour saturation increases in the course of time – the wood darkens. The changes mentioned above are normal for natural raw materials such as wood. This booklet provides some care tips for your piece of furniture so that you can enjoy it for a long time.

The following applies in general:

- Don't place any hot objects on the furniture.
- Don't place candles directly on the furniture.
- Immediately wipe off any spilled liquids.
- Regularly check if the screws and fittings are tight.
- The typical, aromatic wooden odour is always a proof of quality for natural wood furniture.
- The natural emission of resin may produce bright spots on the knots which can be polished with a dry, lintfree cloth.

• Initially, a slight intrinsic odour is unavoidable for other wooden, paint, leather or upholstery materials too. These odours automatically disappear after a while. If you want to speed up this process, ventilate more often at the beginning and/or wipe out the furniture with a slightly damp cloth which was soaked in water mixed with a small amount of vinegar.

Care notes for furniture made of panel materials

We recommend using a soft, lint-free cloth or a shammy for conditioning your piece of furniture made of panel materials. Wipe off the surfaces with a slightly damp cloth or shammy.

The following applies in general:

- Keep these notes in a safe place.
- Don't use the following detergents or cleaning agents at all:
 - **microfibre cloths or dirt erasers**. They often contain fine abrasive particles which can cause scratches on the surfaces;
 - **aggressive chemical substances** as well as **abrasive cleaning agents** or **solvents**. They may damage the surfaces too;
 - **scouring powder, steel wool** or **scouring pads**. They destroy the surface so badly that reconditioning is impossible;
 - **vacuum cleaners**. The nozzles and brushes can cause scratches on the surfaces;
 - **steam cleaners**. The surfaces may be damaged or separated from the ground due to the high pressure and heat of the water vapour.

Dear customer,

Thank you for your order!
A prescindere che abbiate scelto un mobile realizzato in legno naturale, un fronte lucido o un fronte di materiale plastico opaco – ogni esemplare ha sue particolarità. Anche le caratteristiche e la struttura del legno, quali ad esempio rami minori nei mobili di legno naturale, sono parte del fascino individuale di ogni singolo mobile.

Dato che i mobili in legno naturale sono esposti al continuo variare del clima e dell'umidità, è probabile che in superficie insorgano mutamenti quali crepe capillari o cambiamenti di colore. Generalmente con passar del tempo, diminuisce la chiarezza e aumenta la saturazione del colore – il legno si scurisce. I citati mutamenti sono un normale processo dei materiali naturali, quali appunto il legno.

Il presente libretto intende darvi alcuni suggerimenti sulla cura del vostro mobile, affinché vi procuri lunghe soddisfazioni.

Sostanzialmente vale:

- Non poggiare oggetti roventi sui mobili dei mobili.
- Non poggiare candele a diretto contatto dei mobili.
- Asciugare subito i liquidi sversati.
- Ad intervalli periodici controllare se viti e cerniere sono salde.
- Il caratteristico odore fragrante è sempre una prova di qualità dei mobili in legno naturale.
- Le macchie chiare sui rami si formano per via della naturale fuoriuscita di resina, e sono levigabili con un panno asciutto che non lascia peli.
- Anche trattandosi di altri materiali lignei, di vernice, pelle o imbottiti, all'inizio è inevitabile un leggero odore caratteristico. Dopo qualche tempo però, questi odori svaniscono da sé. Potete aiutare a farli volatilizzare in minor tempo cambiando più spesso aria all'inizio e/o passando sui mobili un panno umido d'acqua con qualche goccia d'aceto.
- Conservare bene le presenti istruzioni.

Istruzioni sulla cura dei mobili in materiali pannellati

Per la cura dei mobili in materiali pannellati si consiglia di usare un panno morbido, che non lascia peli, o un panno di pelle. Passare il panno leggermente umido sulle superfici.

Sostanzialmente vale: In nessun caso utilizzare i seguenti detergenti e prodotti per la pulizia:

- **panni in microfibra o spugne a tampono**. Questi prodotti contengono spesso fini particelle abrasive, che possono provocare sgraffiature sui mobili;
- **forti sostanze chimiche nonché detersivi o solventi abrasivi**. Anche questi prodotti possono aggredire le superfici;
- **polvere abrasiva, paglietta d'acciaio** o **spugne abrasive**. Rovineranno la superficie in modo tale che non sarebbe più possibile riparare;
- **aspirapolvere**. Bocchette e spazzole possono sgraffiare le superfici;
- **pulitrice a vapore**. Per via dell'elevata pressione e calore con cui il vapore colpisce le superfici, esse rischiano di deteriorarsi o addirittura staccarsi dalla sottostruttura.

IT

Cher client,

Thank you for your order!
A prescindere que vous ayez choisi un meuble fabriqué en bois naturel, un face haute brillante ou une face en plastique mat – chaque meuble a ses propriétés spécifiques. Même les propriétés et la structure du bois, comme par exemple les petits nœuds sur des meubles en bois naturel, font partie de l'aspect de chaque meuble.

Comme les variations en bois naturel est soumis aux changements permanents du climat et de l'humidité, il se peut que quelques modifications surviennent sur la surface, comme par exemple de fines fissures ou des décorations. En règle générale, au cours du temps, la clarté du meuble diminue et la saturation des couleurs augmente. Les modifications susnommées sont un processus normal des matières naturelles du bois.

Ce petit livret vous donne quelques astuces sur l'entretien de votre meuble pour que vous puissiez en profiter longtemps.

En règle générale :

- Ne pas poser d'objets chauds sur le meuble.
- Ne pas poser de bougies directement sur le meuble.
- Essayer immédiatement les liquides renversés.
- A intervalles réguliers, contrôler que les vis et les ferrures sont bien en place.
- L'odeur aromatique typique du bois est toujours une preuve de qualité des meubles en bois naturel.
- Les endroits clairs sur les nœuds se produisent par une sécrétion naturelle de résine qui s'élimine avec un chiffon sec non pelucheux.
- Les autres matériaux, comme le bois, la peau, le cuir ou le textile, ont un léger dégoût inévitablement une légère odeur. Ces odeurs disparaissent d'elles-mêmes avec le temps. Si vous souhaitez qu'elles disparaissent plus vite, au début, aérez plus souvent et essayez les meubles avec un chiffon légèrement imbibé d'eau mélangée avec un peu de vinaigre.

Conservez bien cette notice.
Consignes de soin pour les meubles avec des plaques en dérivé du bois

Pour l'entretien de votre meuble en plaques en dérivé du bois, utilisez de préférence un chiffon doux non pelucheux à l'eau pe de vinaigre. Essayez.

En règle générale :

- Ne pas poser d'objets chauds sur le meuble.
- Ne pas poser de bougies directement sur le meuble.
- Essayer immédiatement les liquides renversés.
- A intervalles réguliers, contrôler que les vis et les ferrures sont bien en place.
- L'odeur aromatique typique du bois est toujours une preuve de qualité des meubles en bois naturel.
- Les endroits clairs sur les nœuds se produisent par une sécrétion naturelle de résine qui s'élimine avec un chiffon sec non pelucheux.
- Les autres matériaux, comme le bois, la peau, le cuir ou le textile, ont un léger dégoût inévitablement une légère odeur. Ces odeurs disparaissent d'elles-mêmes avec le temps. Si vous souhaitez qu'elles disparaissent plus vite, au début, aérez plus souvent et essayez les meubles avec un chiffon légèrement imbibé d'eau mélangée avec un peu de vinaigre.

Conservare bene le presenti istruzioni.
Consigli di cura per i mobili in materiali pannellati

Per la cura dei mobili in materiali pannellati si consiglia di usare un panno morbido, che non lascia peli, o un panno di pelle. Passare il panno leggermente umido sulle superfici.

Sostanzialmente vale: In nessun caso utilizzare i seguenti detergenti e prodotti per la pulizia:

- **panni in microfibra o spugne a tampono**. Questi prodotti contengono spesso fini particelle abrasive, che possono provocare sgraffiature sui mobili;
- **forti sostanze chimiche nonché detersivi o solventi abrasivi**. Anche questi prodotti possono aggredire le superfici;
- **polvere abrasiva, paglietta d'acciaio** o **spugne abrasive**. Rovineranno la superficie in modo tale che non sarebbe più possibile riparare;
- **aspirapolvere**. Bocchette e spazzole possono sgraffiare le superfici;
- **pulitrice a vapore**. Per via dell'elevata pressione e calore con cui il vapore colpisce le superfici, esse rischiano di deteriorarsi o addirittura staccarsi dalla sottostruttura.

Cher client,

Thank you for your order!
A prescindere che abbiate scelto un mobile realizzato in legno naturale, un fronte lucido o un fronte di materiale plastico opaco – ogni esemplare ha sue particolarità. Anche le caratteristiche e la struttura del legno, quali ad esempio rami minori nei mobili di legno naturale, sono parte del fascino individuale di ogni singolo mobile.

Dato che i mobili in legno naturale sono esposti al continuo variare del clima e dell'umidità, è probabile che in superficie insorgano mutamenti quali crepe capillari o cambiamenti di colore. Generalmente con passar del tempo, diminuisce la chiarezza e aumenta la saturazione del colore – il legno si scurisce. I citati mutamenti sono un normale processo dei materiali naturali, quali appunto il legno.

Il presente libretto intende darvi alcuni suggerimenti sulla cura del vostro mobile, affinché vi procuri lunghe soddisfazioni.

Sostanzialmente vale:

- Non poggiare oggetti roventi sui mobili dei mobili.
- Non poggiare candele a diretto contatto dei mobili.
- Asciugare subito i liquidi sversati.
- Ad intervalli periodici controllare se viti e cerniere sono salde.
- Il caratteristico odore fragrante è sempre una prova di qualità dei mobili in legno naturale.
- Le macchie chiare sui rami si formano per via della naturale fuoriuscita di resina, e sono levigabili con un panno asciutto che non lascia peli.
- Anche trattandosi di altri materiali lignei, di vernice, pelle o imbottiti, all'inizio è inevitabile un leggero odore caratteristico. Dopo qualche tempo però, questi odori svaniscono da sé. Potete aiutare a farli volatilizzare in minor tempo cambiando più spesso aria all'inizio e/o passando sui mobili un panno umido d'acqua con qualche goccia d'aceto.
- Conservare bene le presenti istruzioni.

Istruzioni sulla cura dei mobili in materiali pannellati

Per la cura dei mobili in materiali pannellati si consiglia di usare un panno morbido, che non lascia peli, o un panno di pelle. Passare il panno leggermente umido sulle superfici.

Sostanzialmente vale: In nessun caso utilizzare i seguenti detergenti e prodotti per la pulizia:

- **panni in microfibra o spugne a tampono**. Questi prodotti contengono spesso fini particelle abrasive, che possono provocare sgraffiature sui mobili;
- **forti sostanze chimiche nonché detersivi o solventi abrasivi**. Anche questi prodotti possono aggredire le superfici;
- **polvere abrasiva, paglietta d'acciaio** o **spugne abrasive**. Rovineranno la superficie in modo tale che non sarebbe più possibile riparare;
- **aspirapolvere**. Bocchette e spazzole possono sgraffiare le superfici;
- **pulitrice a vapore**. Per via dell'elevata pressione e calore con cui il vapore colpisce le superfici, esse rischiano di deteriorarsi o addirittura staccarsi dalla sottostruttura.

Cher client,

Thank you for your order!
A prescindere que vous ayez choisi un meuble fabriqué en bois naturel, un face haute brillante ou une face en plastique mat – chaque meuble a ses propriétés spécifiques. Même les propriétés et la structure du bois, comme par exemple les petits nœuds sur des meubles en bois naturel, font partie de l'aspect de chaque meuble.

Comme les variations en bois naturel est soumis aux changements permanents du climat et de l'humidité, il se peut que quelques modifications surviennent sur la surface, comme par exemple de fines fissures ou des décorations. En règle générale, au cours du temps, la clarté du meuble diminue et la saturation des couleurs augmente. Les modifications susnommées sont un processus normal des matières naturelles du bois.

Ce petit livret vous donne quelques astuces sur l'entretien de votre meuble pour que vous puissiez en profiter longtemps.

En règle générale :

- Ne pas poser d'objets chauds sur le meuble.
- Ne pas poser de bougies directement sur le meuble.
- Essayer immédiatement les liquides renversés.
- A intervalles réguliers, contrôler que les vis et les ferrures sont bien en place.
- L'odeur aromatique typique du bois est toujours une preuve de qualité des meubles en bois naturel.
- Les endroits clairs sur les nœuds se produisent par une sécrétion naturelle de résine qui s'élimine avec un chiffon sec non pelucheux.
- Les autres matériaux, comme le bois, la peau, le cuir ou le textile, ont un léger dégoût inévitablement une légère odeur. Ces odeurs disparaissent d'elles-mêmes avec le temps. Si vous souhaitez qu'elles disparaissent plus vite, au début, aérez plus souvent et essayez les meubles avec un chiffon légèrement imbibé d'eau mélangée avec un peu de vinaigre.

Conservez bien cette notice.
Consignes de soin pour les meubles avec des plaques en dérivé du bois

Pour l'entretien de votre meuble en plaques en dérivé du bois, utilisez de préférence un chiffon doux non pelucheux à l'eau pe de vinaigre. Essayez.

En règle générale :

- Ne pas poser d'objets chauds sur le meuble.
- Ne pas poser de bougies directement sur le meuble.
- Essayer immédiatement les liquides renversés.
- A intervalles réguliers, contrôler que les vis et les ferrures sont bien en place.
- L'odeur aromatique typique du bois est toujours une preuve de qualité des meubles en bois naturel.
- Les endroits clairs sur les nœuds se produisent par une sécrétion naturelle de résine qui s'élimine avec un chiffon sec non pelucheux.
- Les autres matériaux, comme le bois, la peau, le cuir ou le textile, ont un léger dégoût inévitablement une légère odeur. Ces odeurs disparaissent d'elles-mêmes avec le temps. Si vous souhaitez qu'elles disparaissent plus vite, au début, aérez plus souvent et essayez les meubles avec un chiffon légèrement imbibé d'eau mélangée avec un peu de vinaigre.

Area Sviluppo prodotti

Your product development team



Uwaga - Upozornění - Achtung - Attention - Caution - Figyelem
 Attenzione - Opgelet - Atenție - Upozornenie - Dikkat

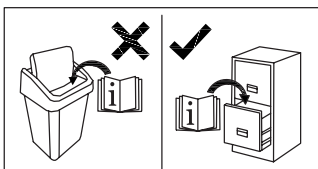
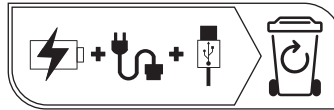
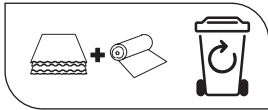
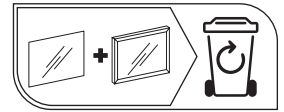
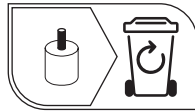
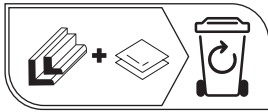
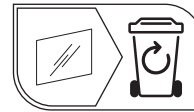
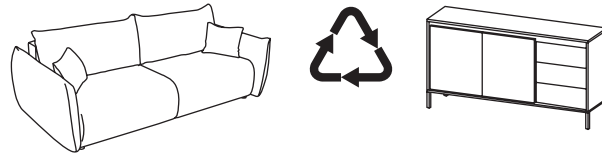
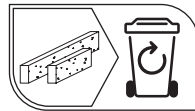
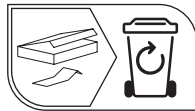
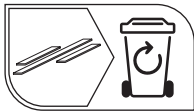
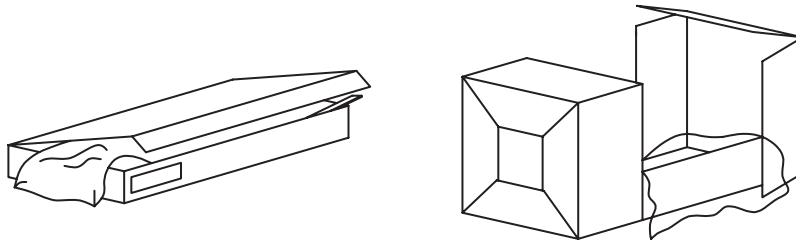

Producent - Produzent - Üretici - Producteur - Výrobce -
 Termelő - Produser - Produttore - Producător - Productor

MEBLE LASKI KACZOROWSKA SP.K.

Laski, ul. Kępińska 21, 63-620 Trzcinica
 meble-laski@meble-laski.com.pl



Uwaga - Upozornění - Achtung - Attention - Caution - Figyelem
 Attenzione - Opgelet - Atenție - Upozornenie - Dikkat

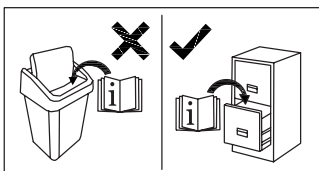
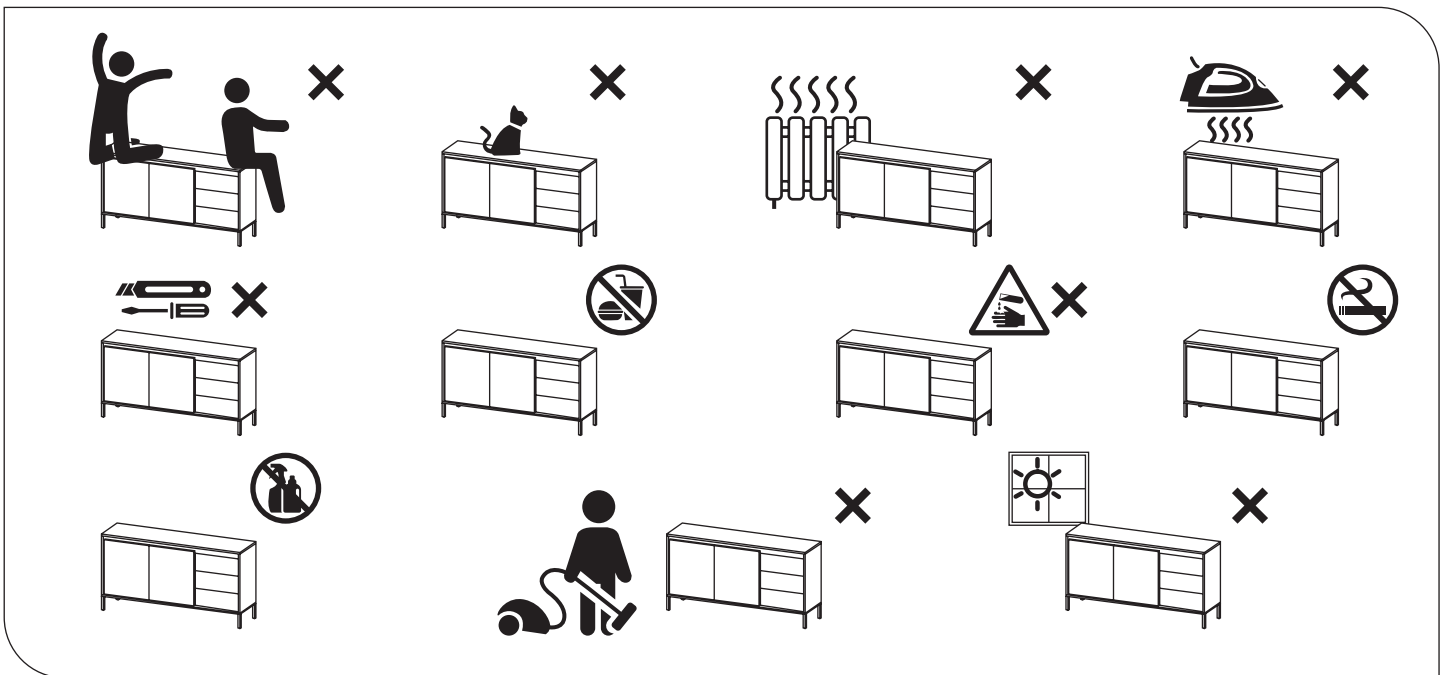
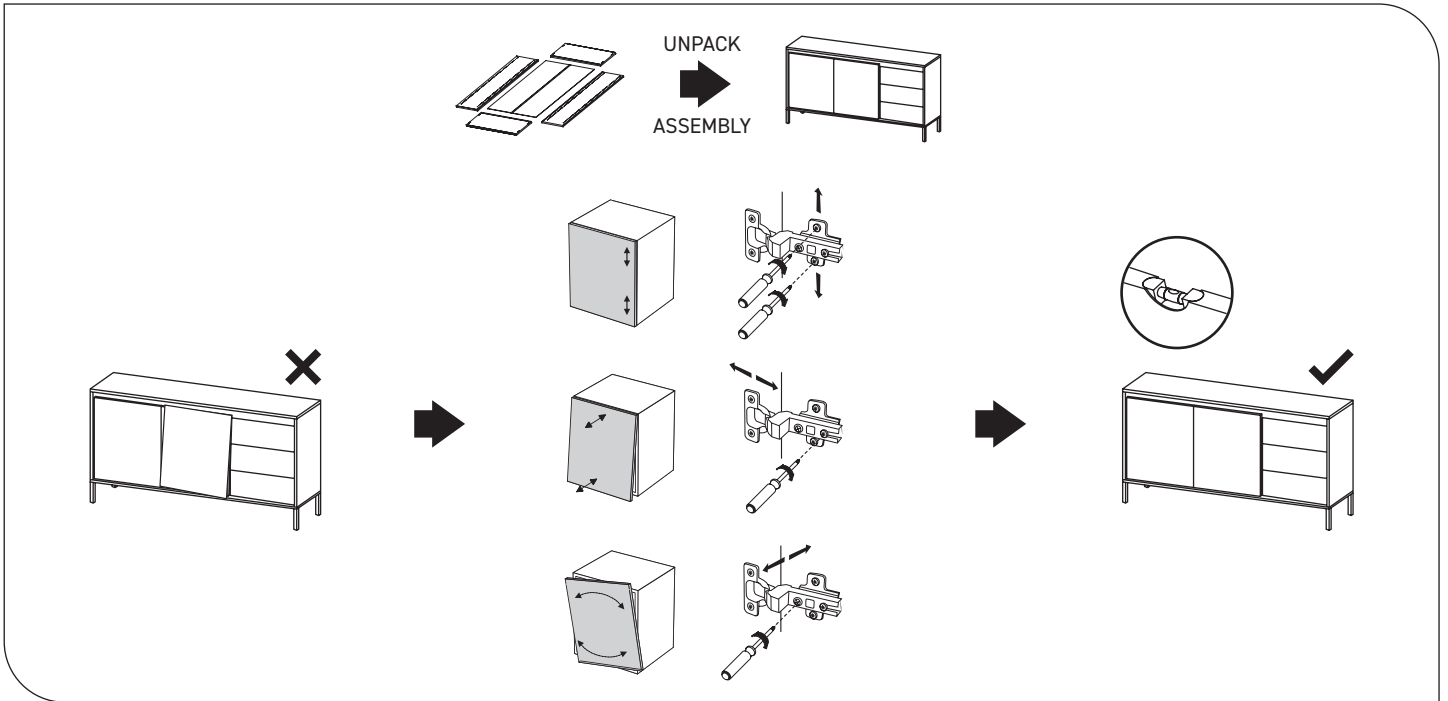
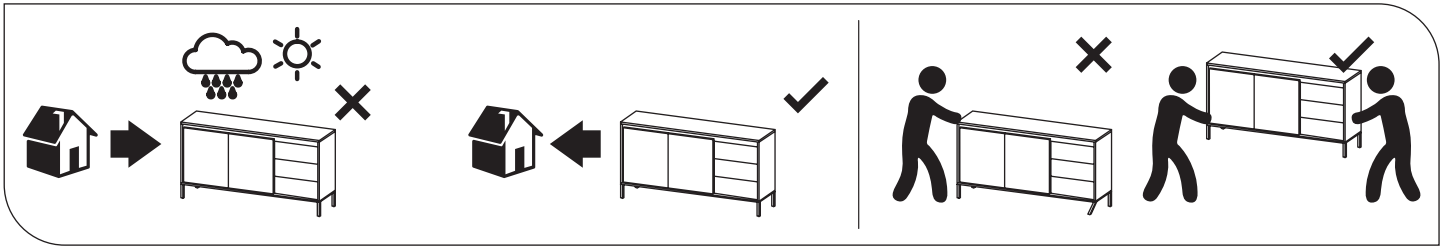

Producent - Produzent - Üretici - Producteur - Výrobce -
 Termelő - Producer - Produttore - Producător - Productor

MEBLE LASKI KACZOROWSKA SP.K.
 Laski, ul. Kępińska 21, 63-620 Trzcinica
 meble-laski@meble-laski.com.pl